

# Dell EMC PowerEdge R740xd

## Installation and Service Manual

## Notes, cautions, and warnings

 **NOTE:** A NOTE indicates important information that helps you make better use of your product.

 **CAUTION:** A CAUTION indicates either potential damage to hardware or loss of data and tells you how to avoid the problem.

 **WARNING:** A WARNING indicates a potential for property damage, personal injury, or death.

**Copyright © 2017 Dell Inc. or its subsidiaries. All rights reserved.** Dell, EMC, and other trademarks are trademarks of Dell Inc. or its subsidiaries. Other trademarks may be trademarks of their respective owners.

# Contents

<b>1 PowerEdge R740xd system overview.....</b>	<b>8</b>
Supported configurations.....	8
Front view of the system.....	10
Left control panel view.....	11
Right control panel view.....	14
Back view of the system.....	15
NIC indicator codes.....	17
Power supply unit indicator codes.....	17
Drive indicator codes.....	19
LCD panel.....	20
Viewing Home screen.....	21
Setup menu.....	21
View menu.....	22
Locating Service Tag of your system.....	22
<b>2 Documentation resources.....</b>	<b>23</b>
<b>3 Technical specifications.....</b>	<b>25</b>
System dimensions.....	25
Chassis weight.....	26
Processor specifications.....	27
PSU specifications.....	27
System battery specifications.....	27
Expansion bus specifications.....	27
Memory specifications.....	29
Storage controller specifications.....	29
Drive specifications.....	29
Drives.....	30
Ports and connectors specifications.....	30
USB ports.....	30
NIC ports.....	30
VGA ports.....	31
Serial connector.....	31
Internal Dual SD Module/vFlash card.....	31
Video specifications.....	31
Environmental specifications.....	32
Standard operating temperature.....	33
Expanded operating temperature.....	33
Particulate and gaseous contamination specifications.....	35
<b>4 Initial system setup and configuration.....</b>	<b>37</b>
Setting up your system.....	37

iDRAC configuration.....	37
Options to set up iDRAC IP address.....	37
Log in to iDRAC.....	38
Options to install the operating system.....	38
Methods to download firmware and drivers.....	39
Downloading drivers and firmware.....	39
<b>5 Pre-operating system management applications.....</b>	<b>40</b>
Options to manage the pre-operating system applications.....	40
System Setup.....	40
Viewing System Setup.....	41
System Setup details.....	41
System BIOS.....	42
iDRAC Settings utility.....	61
Device Settings.....	62
Dell Lifecycle Controller.....	62
Embedded system management.....	62
Boot Manager.....	62
Viewing Boot Manager.....	62
Boot Manager main menu.....	63
One-shot BIOS boot menu.....	63
System Utilities.....	63
PXE boot.....	63
<b>6 Installing and removing system components.....</b>	<b>64</b>
Safety instructions.....	64
Before working inside your system.....	64
After working inside your system.....	64
Recommended tools.....	65
Optional front bezel.....	65
Removing the optional front bezel.....	65
Installing the optional front bezel.....	66
System cover.....	67
Removing the system cover.....	67
Installing the system cover.....	68
Backplane cover.....	69
Removing the backplane cover.....	69
Installing the backplane cover.....	70
Inside the system.....	71
Air shroud.....	73
Removing the air shroud.....	74
Installing the air shroud.....	74
Cooling fan assembly.....	75
Removing the cooling fan assembly.....	75
Installing the cooling fan assembly.....	76
Cooling fans.....	77

Removing a cooling fan.....	78
Installing a cooling fan.....	79
Intrusion switch.....	79
Removing an intrusion switch.....	80
Installing an intrusion switch.....	80
NVDIMM-N battery.....	81
Removing the NVDIMM-N battery from the air shroud.....	81
Installing NVDIMM-N battery into air shroud.....	82
Removing NVDIMM-N battery from mid drive tray.....	83
Installing NVDIMM-N battery into mid drive tray.....	84
Removing NVDIMM-N battery from the bracket.....	85
Installing NVDIMM-N battery into the bracket.....	86
Mid drive tray.....	87
Removing mid drive tray.....	87
Installing the mid drive tray.....	88
Removing drive blank from drive carrier.....	89
Installing drive blank into the drive carrier.....	90
Removing drive carrier from the mid drive tray.....	90
Installing drive carrier into mid drive tray.....	91
Removing 3.5 inch drive from the drive carrier.....	92
Installing 3.5 inch drive into the drive carrier.....	93
Removing 2.5 inch drive from the 3.5 inch drive adapter.....	94
Installing 2.5 inch drive into the 3.5 inch drive adapter.....	95
Removing 3.5 inch drive adapter from 3.5 inch drive carrier.....	96
Installing 3.5 inch drive adapter into the drive carrier.....	97
Drives.....	98
Removing a drive blank.....	98
Installing a drive blank.....	99
Removing a drive carrier.....	100
Installing a drive carrier.....	101
Removing the drive from the drive carrier.....	102
Installing a drive into the drive carrier.....	103
Rear drive cage.....	104
Removing rear drive cage.....	104
Installing rear drive cage.....	106
System memory.....	107
General memory module installation guidelines.....	109
NVDIMM-N memory module installation guidelines.....	109
Mode-specific guidelines.....	109
Removing a memory module.....	111
Installing a memory module.....	112
Processors and heat sinks.....	113
Removing a processor and heat sink module.....	114
Removing the processor from the processor and heat sink module.....	115
Installing the processor into a processor and heat sink module.....	117

Installing a processor and heat sink module.....	119
Expansion cards and expansion card risers.....	121
Expansion card installation guidelines.....	121
Opening and closing the PCIe card holder latch.....	125
Removing the expansion card from expansion card riser.....	126
Installing expansion card into expansion card riser.....	129
Removing riser 2 and 3 blank.....	131
Installing riser 2 and 3 blank.....	132
Removing riser 3 blank.....	133
Installing riser 3 blank.....	134
Removing expansion card riser 1.....	135
Installing expansion card riser 1.....	136
Removing expansion card riser 2.....	137
Installing expansion card riser 2.....	138
Removing expansion card riser 3.....	140
Installing expansion card riser 3.....	141
IDSDM/vFlash card (optional).....	141
Removing the micro SD card.....	142
Installing the micro SD card.....	142
Removing the optional IDSDM or vFlash card.....	142
Installing optional IDSDM or vFlash card.....	143
Network daughter card.....	144
Removing the network daughter card.....	144
Installing the network daughter card.....	145
Integrated storage controller card.....	146
Removing integrated storage controller card.....	146
Installing integrated storage controller card.....	148
Drive backplane.....	149
Drive backplane connectors.....	149
Removing drive backplane .....	151
Installing drive backplane.....	152
Removing drive backplane (mid).....	153
Installing drive backplane (mid).....	154
Removing 3.5 inch drive backplane (rear).....	155
Installing 3.5 inch drive backplane (rear).....	156
Removing the 2.5 inch drive backplane (rear).....	157
Installing the 2.5 inch drive backplane (rear).....	157
Cable routing.....	159
System battery.....	171
Replacing the system battery.....	171
Internal USB memory key (optional).....	172
Replacing optional internal USB memory key.....	173
Power supply units.....	173
Hot spare feature.....	174
Removing a power supply unit blank.....	174

Installing a power supply unit blank.....	175
Removing a power supply unit.....	175
Installing a power supply unit.....	176
Wiring instructions for a DC power supply unit.....	177
System board.....	179
Removing system board.....	179
Installing system board.....	180
Trusted Platform Module.....	183
Replacing the Trusted Platform Module.....	183
Initializing TPM for BitLocker users.....	184
Initializing the TPM 1.2 for TXT users.....	184
Initializing the TPM 2.0 for TXT users.....	184
Control panel.....	184
Removing the left control panel.....	185
Installing the left control panel.....	185
Removing the right control panel.....	186
Installing the right control panel.....	187
<b>7 Using system diagnostics.....</b>	<b>189</b>
Dell Embedded System Diagnostics.....	189
Running the Embedded System Diagnostics from Boot Manager.....	189
Running the Embedded System Diagnostics from the Dell Lifecycle Controller.....	189
System diagnostic controls.....	190
<b>8 Jumpers and connectors .....</b>	<b>191</b>
System board jumpers and connectors.....	192
System board jumper settings.....	194
Disabling forgotten password.....	194
<b>9 Getting help.....</b>	<b>196</b>
Contacting Dell.....	196
Documentation feedback.....	196
Accessing system information by using QRL.....	196
Quick Resource Locator for PowerEdge R740 and R740xd systems.....	197
Receiving automated support with SupportAssist .....	197

# PowerEdge R740xd system overview

The PowerEdge R740xd is a 2U rack server that supports up to:

- Two Intel Xeon Processor Scalable Family processors
- 24 DIMM slots supporting up to 1536 GB of memory
- Two AC or DC power supply units
- 32 SAS, SATA, Nearline SAS hard drives or SSDs, and up to 24 NVMe drives. For more information about supported drives, see the Technical specifications section.

**NOTE:** All instances of SAS, SATA hard drives, NVMe and SSDs are referred to as drives in this document, unless specified otherwise.

Topics:

- [Supported configurations](#)
- [Front view of the system](#)
- [Back view of the system](#)
- [Drive indicator codes](#)
- [LCD panel](#)
- [Locating Service Tag of your system](#)

## Related link

[Technical specifications](#)

## Supported configurations

The PowerEdge R740xd system supports the following configurations:



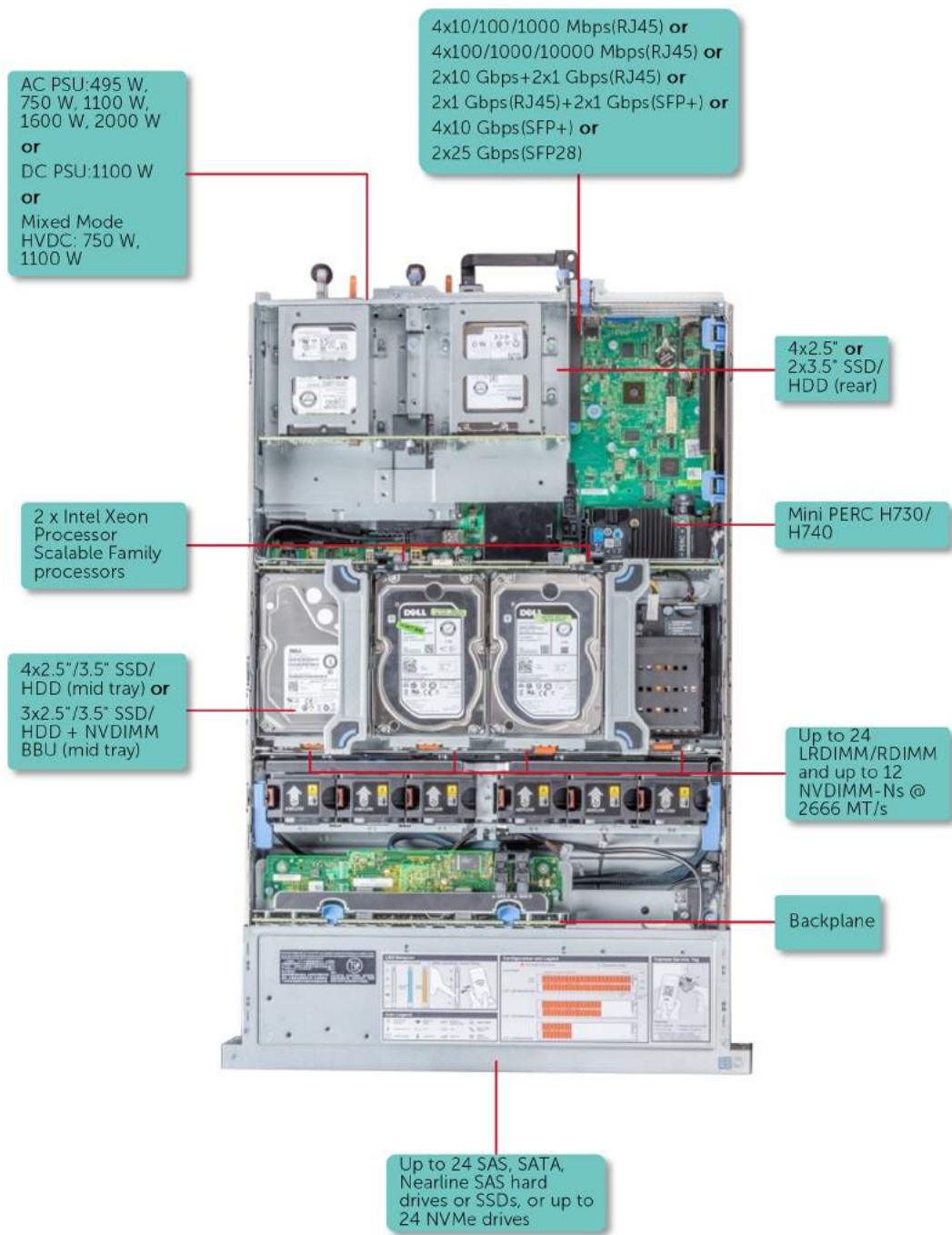

Figure 1. Supported configurations

# Front view of the system

The front view displays the features available on the front of the system.



**Figure 2. Front view of 24 x 2.5 inch drive system**



**Figure 3. Front view of 12 x 3.5 inch drive system**

**Table 1. Features available on the front of the system**

Item	Panels and slots	Icon	Description
1	Left control panel	N/A	Contains system health and system ID, status LED or optional iDRAC Quick Sync 2 (wireless).
2	Drives	N/A	Enable you to install drives that are supported on your system. For more information about drives, see the Technical specifications section.
3	Right control panel	N/A	Contains the power button, VGA port, iDRAC Direct micro USB port and two USB 2.0 ports.
4	Information tag	N/A	The Information Tag is a slide-out label panel that contains system information such as Service Tag, NIC, MAC address, and so on. If you have opted for secure default access to iDRAC, the Information tag also contains the iDRAC secure default password.

## Left control panel view

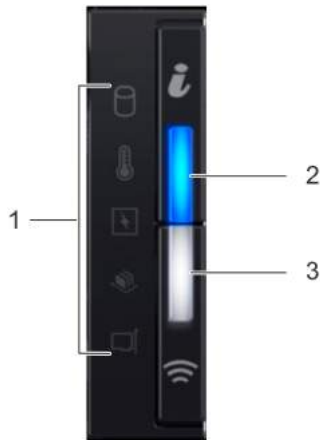

Figure 4. Left control panel view

Table 2. Left control panel features

Item	Indicator, button, or connector	Icon	Description
1	Status LED indicators	N/A	Indicate the status of the system. For more information, see the Status LED indicators section.
2	System health and system ID indicator		Indicates the system health. For more information, see the System health and system ID indicator codes section.
3	iDRAC Quick Sync 2 wireless indicator (optional)		Indicates if the iDRAC Quick Sync 2 wireless option is activated. The Quick Sync 2 feature allows management of the system using mobile devices. This feature aggregates hardware/firmware inventory and various system level diagnostic/error information that can be used in troubleshooting the system. You can access system inventory, Dell Lifecycle Controller logs or system logs, system health status, and also configure iDRAC, BIOS, and networking parameters. You can also launch the virtual Keyboard, Video, and Mouse (KVM) viewer and virtual Kernel based Virtual Machine (KVM), on a supported mobile device. For more information, see the Integrated Dell Remote Access Controller User's Guide at <a href="http://Dell.com/idracmanuals">Dell.com/idracmanuals</a> .

### Related link





[Status LED indicators](#)

[System health and system ID indicator codes](#)

## Status LED indicators

**NOTE:** The status LED indicators are always off and only turns on to a solid amber if any error occurs.

**Table 3. Status LED indicators and descriptions**

Icon	Description	Condition	Corrective action
	Drive indicator	The indicator turns solid amber if there is a drive error.	<ul style="list-style-type: none"> <li>Check the System Event Log to determine if the drive has an error.</li> <li>Run the appropriate Online Diagnostics test. Restart the system and run embedded diagnostics (ePSA).</li> <li>If the drives are configured in a RAID array, restart the system, and enter the host adapter configuration utility program.</li> </ul>
	Temperature indicator	The indicator turns solid amber if the system experiences a thermal error (for example, the ambient temperature is out of range or there is a fan failure).	<p>Ensure that none of the following conditions exist:</p> <ul style="list-style-type: none"> <li>A cooling fan has been removed or has failed.</li> <li>System cover, air shroud, memory module blank, or back filler bracket is removed.</li> <li>Ambient temperature is too high.</li> <li>External airflow is obstructed.</li> </ul> <p>If the problem persists, see the Getting help section.</p>
	Electrical indicator	The indicator turns solid amber if the system experiences an electrical error (for example, voltage out of range, or a failed power supply unit (PSU) or voltage regulator).	Check the System Event Log or system messages for the specific issue. If it is due to a problem with the PSU, check the LED on the PSU. Reseat the PSU. If the problem persists, see the Getting help section.
	Memory indicator	The indicator turns solid amber if a memory error occurs.	Check the System Event Log or system messages for the location of the failed memory. Reseat the memory module. If the problem persists, see the Getting help section.
	PCIe indicator	The indicator turns solid amber if a PCIe card experiences an error.	Restart the system. Update any required drivers for the PCIe card. Reinstall the card. If the problem persists, see the Getting help section.

**NOTE:** For more information about the supported PCIe cards, see the Expansion card installation guidelines section.

**Related link**

- [Getting help](#)
- [Expansion card installation guidelines](#)

## System health and system ID indicator codes

The system health and system ID indicator is located on the left control panel of your system.



**Figure 5. System health and system ID indicators**

**Table 4. System health and system ID indicator codes**

System health and system ID indicator code	Condition
Solid blue	Indicates that the system is turned on, system is healthy, and system ID mode is not active. Press the system health and system ID button to switch to system ID mode.
Blinking blue	Indicates that the system ID mode is active. Press the system health and system ID button to switch to system health mode.
Solid amber	Indicates that the system is in fail-safe mode. If the problem persists, see the Getting help section.
Blinking amber	Indicates that the system is experiencing a fault. Check the System Event Log or the LCD panel, if available on the bezel, for specific error message. For more information about error messages, see the <i>Dell Event and Error Messages Reference Guide</i> at <a href="http://Dell.com/openmanagemanuals">Dell.com/openmanagemanuals</a> > <b>OpenManage software</b> .

**Related link**

[Getting help](#)

## iDRAC Quick Sync 2 indicator codes

iDRAC Quick Sync 2 module (optional) is located on the left control panel of your system.



**Figure 6. iDRAC Quick Sync 2 indicators**

**Table 5. iDRAC Quick Sync 2 indicators and descriptions**

iDRAC Quick Sync 2 indicator code	Condition	Corrective action
Off (default state)	Indicates that the iDRAC Quick Sync 2 feature is turned off. Press the iDRAC Quick Sync 2 button to turn on the iDRAC Quick Sync 2 feature.	If the LED fails to turn on, reseal the left control panel flex cable and check again. If the problem persists, see the Getting help section.
Solid white	Indicates that iDRAC Quick Sync 2 is ready to communicate. Press the iDRAC Quick Sync 2 button to turn off.	If the LED fails to turn off, restart the system. If the problem persists, see the Getting help section.
Blinks white rapidly	Indicates data transfer activity.	If the indicator continues to blink indefinitely, see the Getting help section.
Blinks white slowly	Indicates that firmware update is in progress.	If the indicator continues to blink indefinitely, see the Getting help section.
Blinks white five times rapidly and then turns off	Indicates that the iDRAC Quick Sync 2 feature is disabled.	Check if iDRAC Quick Sync 2 feature is configured to be disabled by iDRAC. If the problem persists, see the Getting help section. For more information, see <i>Integrated Dell Remote Access Controller User's</i>

iDRAC Quick Sync 2 indicator code	Condition	Corrective action
Solid amber	Indicates that the system is in fail-safe mode.	Restart the system. If the problem persists, see the Getting help section.
Blinking amber	Indicates that the iDRAC Quick Sync 2 hardware is not responding properly.	Restart the system. If the problem persists, see the Getting help section.

**Related link**

[Getting help](#)

## Right control panel view

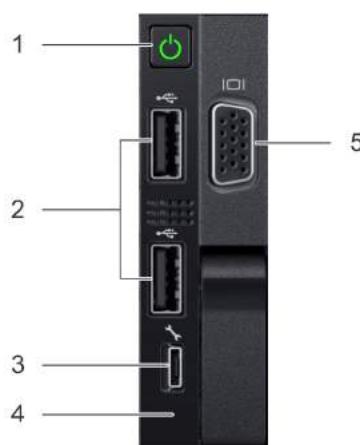



Figure 7. Right control panel view

Table 6. Right control panel features

Item	Indicator, button, or connector	Icon	Description
1	Power button		Indicates if the system is turned on or off. Press the power button to manually turn on or off the system.  <b>NOTE:</b> Press the power button to gracefully shut down an ACPI-compliant operating system.
2	USB port (2)		The USB ports are 4-pin, 2.0-compliant. These ports enable you to connect USB devices to the system.
3	iDRAC Direct port		The iDRAC Direct port is micro USB 2.0-compliant. This port enables you to access the iDRAC Direct features. For more information, see the iDRAC User's Guide at <a href="#">Dell.com/idracmanuals</a> .
4	iDRAC Direct LED	N/A	The iDRAC Direct LED indicator lights up to indicate that the iDRAC Direct port is connected. For more information, see the iDRAC Direct LED indicator codes section.

Item	Indicator, button, or connector	Icon	Description
5	VGA port		Enables you to connect a display device to the system. For more information, see the Technical specifications section.

**Related link**

- [iDRAC Direct LED indicator codes](#)
- [Technical specifications](#)

## iDRAC Direct LED indicator codes

The iDRAC Direct LED indicator lights up to indicate that the port is connected and is being used as a part of the iDRAC subsystem.

iDRAC Direct LED indicator is located below the iDRAC Direct port on the right control panel.

You can configure iDRAC Direct by using a USB to micro USB (type AB) cable, which you can connect to your laptop or tablet. The following table describes iDRAC Direct activity when the iDRAC Direct port is active:

**Table 7. iDRAC Direct LED indicator codes**

iDRAC Direct LED indicator code	Condition
Solid green for two seconds	Indicates that the laptop or tablet is connected.
Flashing green (on for two seconds and off for two seconds)	Indicates that the laptop or tablet connected is recognized.
Turns off	Indicates that the laptop or tablet is unplugged.

## Back view of the system

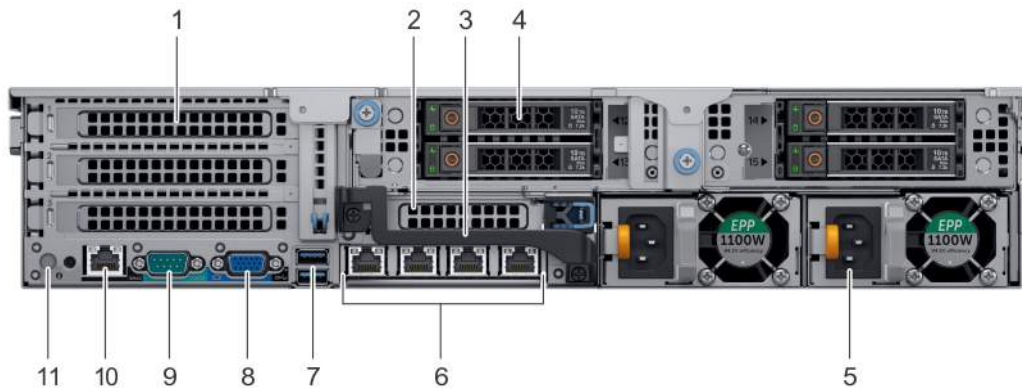







**Figure 8. Back view of 4 x 2.5 inch drive system**





**Figure 9. Back view of 2 x 3.5 inch drive system**

**Table 8. Features available on the back view**

Item	Panels, ports and slots	Icon	Description
1	Full-height PCIe expansion card slot (3)	N/A	The PCIe expansion card slot (riser 1) connects up to three full-height PCIe expansion cards to the system. For more information, see the Expansion card installation guidelines section.
2	Half-height PCIe expansion card slot	N/A	The PCIe expansion card slot (riser 2) connects one half-height PCIe expansion cards to the system. For more information, see the Expansion card installation guidelines section.
3	Rear handle	N/A	The rear handle can be removed to enable any external cabling of PCIe cards that are installed in the PCIe expansion card slot 6.
4	Drives	N/A	Enable you to install drives that are supported on your system. For more information about drives, see the Technical specifications section.
4	Power supply unit (2)	N/A	For more information, see the Technical specifications section.
6	NIC ports		The NIC ports that are integrated on the network daughter card (NDC) provide network connectivity. For more information about the supported configurations, see the Technical specifications section.
7	USB port (2)		The USB ports are 9-pin and 3.0-compliant. These ports enable you to connect USB devices to the system.
8	VGA port		Enables you to connect a display device to the system. For more information, see the Technical specifications section.
9	Serial port		Enables you to connect a serial device to the system. For more information, see the Technical specifications section.
10	iDRAC9 dedicated port		Enables you to remotely access iDRAC. For more information, see the iDRAC User's Guide at <a href="http://Dell.com/idracmanuals">Dell.com/idracmanuals</a> .
11	System identification button		The System Identification (ID) button is available on the front and back of the systems. Press the button to identify a system in a rack by turning on the system ID button. You can also use the system ID button to reset iDRAC and to access BIOS using the step through mode.



## NIC indicator codes

Each NIC on the back panel has indicators that provide information about the activity and link status. The activity LED indicator indicates if data is flowing through the NIC, and the link LED indicator indicates the speed of the connected network.

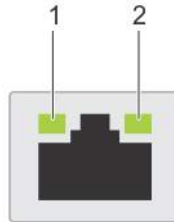

Figure 10. NIC indicator codes

- 1 link LED indicator
- 2 activity LED indicator

Table 9. NIC indicator codes

Status	Condition
Link and activity indicators are off	The NIC is not connected to the network.
Link indicator is green and activity indicator is blinking green	The NIC is connected to a valid network at its maximum port speed and data is being sent or received.
Link indicator is amber and activity indicator is blinking green	The NIC is connected to a valid network at less than its maximum port speed and data is being sent or received.
Link indicator is green and activity indicator is off	The NIC is connected to a valid network at its maximum port speed and data is not being sent or received.
Link indicator is amber and activity indicator is off	The NIC is connected to a valid network at less than its maximum port speed and data is not being sent or received.
Link indicator is blinking green and activity is off	NIC identify is enabled through the NIC configuration utility.

## Power supply unit indicator codes

AC power supply units (PSUs) have an illuminated translucent handle that serves as an indicator and DC PSUs have an LED that serves as an indicator. The indicator shows whether power is present or a power fault has occurred.

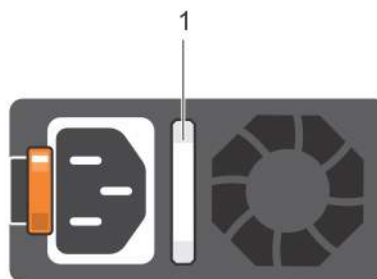
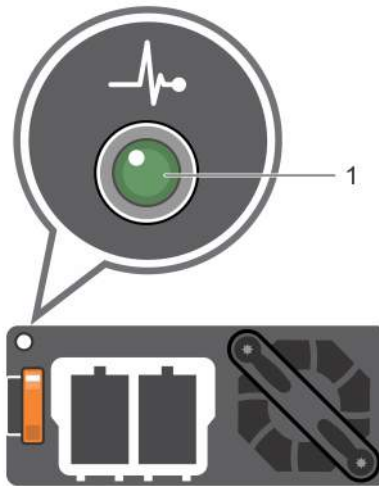

Figure 11. AC PSU status indicator

- 1 AC PSU status indicator/handle

**Table 10. AC PSU status indicator codes**

Power indicator codes	Condition
Green	A valid power source is connected to the PSU and the PSU is operational.
Blinking amber	Indicates a problem with the PSU.
Not illuminated	Power is not connected to the PSU.
Blinking green	When the firmware of the PSU is being updated, the PSU handle blinks green.
	<p>⚠ <b>CAUTION:</b> Do not disconnect the power cord or unplug the PSU when updating firmware. If firmware update is interrupted, the PSUs do not function.</p>
Blinking green and turns off	<p>When hot-plugging a PSU, the PSU handle blinks green five times at a rate of 4 Hz and turns off. This indicates a PSU mismatch with respect to efficiency, feature set, health status, or supported voltage.</p> <p>⚠ <b>CAUTION:</b> If two PSUs are installed, both the PSUs must have the same type of label; for example, Extended Power Performance (EPP) label. Mixing PSUs from previous generations of PowerEdge servers is not supported, even if the PSUs have the same power rating. This results in a PSU mismatch condition or failure to turn the system on.</p> <p>⚠ <b>CAUTION:</b> When correcting a PSU mismatch, replace only the PSU with the blinking indicator. Swapping the PSU to make a matched pair can result in an error condition and unexpected system shutdown. To change from a high output configuration to a low output configuration or vice versa, you must turn off the system.</p> <p>⚠ <b>CAUTION:</b> AC PSUs support both 240 V and 120 V input voltages with the exception of Titanium PSUs, which support only 240 V. When two identical PSUs receive different input voltages, they can output different wattages, and trigger a mismatch.</p> <p>⚠ <b>CAUTION:</b> If two PSUs are used, they must be of the same type and have the same maximum output power.</p> <p>⚠ <b>CAUTION:</b> Combining AC and DC PSUs is not supported and triggers a mismatch.</p>



**Figure 12. DC PSU status indicator**

1 DC PSU status indicator

**Table 11. DC PSU status indicator codes**

Power indicator codes	Condition
Green	A valid power source is connected to the PSU and the PSU is operational.
Blinking amber	Indicates a problem with the PSU.
Not illuminated	Power is not connected to the PSU.
Blinking green	When hot-plugging a PSU, the PSU indicator blinks green. This indicates that there is a PSU mismatch with respect to efficiency, feature set, health status, or supported voltage. <ul style="list-style-type: none"> <li>△ <b>CAUTION:</b> If two PSUs are installed, both the PSUs must have the same type of label; for example, Extended Power Performance (EPP) label. Mixing PSUs from previous generations of PowerEdge servers is not supported, even if the PSUs have the same power rating. This results in a PSU mismatch condition or failure to turn the system on.</li> <li>△ <b>CAUTION:</b> When correcting a PSU mismatch, replace only the PSU with the blinking indicator. Swapping the PSU to make a matched pair can result in an error condition and unexpected system shutdown. To change from a High Output configuration to a Low Output configuration or vice versa, you must turn off the system.</li> <li>△ <b>CAUTION:</b> If two PSUs are used, they must be of the same type and have the same maximum output power.</li> <li>△ <b>CAUTION:</b> Combining AC and DC PSUs is not supported and triggers a mismatch.</li> </ul>

## Drive indicator codes

Each drive carrier has an activity LED indicator and a status LED indicator. The indicators provide information about the current status of the drive. The activity LED indicator indicates whether the drive is currently in use or not. The status LED indicator indicates the power condition of the drive.

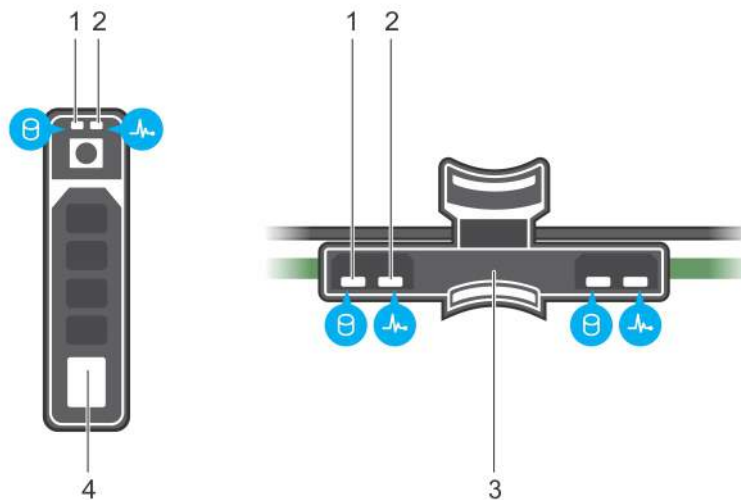

**Figure 13. Drive indicators on the drive and the mid drive tray backplane**

- |   |                                   |   |                            |
|---|-----------------------------------|---|----------------------------|
| 1 | drive activity LED indicator      | 2 | drive status LED indicator |
| 3 | drive backplane on mid drive tray | 4 | drive                      |

**NOTE:** If the drive is in the Advanced Host Controller Interface (AHCI) mode, the status LED indicator does not turn on.

**Table 12. Drive indicator codes**

Drive status indicator code	Condition
Flashes green twice per second	Identifying drive or preparing for removal.
Off	Drive ready for removal.
	<b>NOTE:</b> The drive status indicator remains off until all drives are initialized after the system is turned on. Drives are not ready for removal during this time.
Flashes green, amber, and then turns off	Predicted drive failure.
Flashes amber four times per second	Drive failed.
Flashes green slowly	Drive rebuilding.
Solid green	Drive online.
Flashes green for three seconds, amber for three seconds, and then turns off after six seconds	Rebuild stopped.

## LCD panel

The LCD panel provides system information, status, and error messages to indicate if the system is functioning correctly or requires attention. The LCD panel can be used to configure or view the system's iDRAC IP address. For more information about error messages, see the *Dell Event and Error Messages Reference Guide* at [Dell.com/openmanagemanuals](http://Dell.com/openmanagemanuals) > **OpenManage software**.

The LCD panel is available only on the optional LCD bezel. The optional LCD bezel is hot pluggable.

The statuses and conditions of the LCD panel are outlined here:

- The LCD backlight is white during normal operating conditions.
- When the system needs attention, the LCD backlight turns amber, and displays an error code followed by descriptive text.

**NOTE:** If the system is connected to a power source and an error is detected, the LCD turns amber regardless of whether the system is turned on or off.

- When the system turns off and there are no errors, LCD enters the standby mode after five minutes of inactivity. Press any button on the LCD to turn it on.
- If the LCD panel stops responding, remove the bezel and reinstall it. If the problem persists, see the Getting help section.
- The LCD backlight remains off if LCD messaging is turned off using the iDRAC utility, the LCD panel, or other tools.



**Figure 14. LCD panel features**

**Table 13. LCD panel features**



Item	Button or display	Description
1	Left	Moves the cursor back in one-step increments.
2	Select	Selects the menu item highlighted by the cursor.
3	Right	Moves the cursor forward in one-step increments. During message scrolling: <ul style="list-style-type: none"> <li>Press and hold the right button to increase scrolling speed.</li> <li>Release the button to stop.</li> </ul>
		<p><b>NOTE:</b> The display stops scrolling when the button is released. After 45 seconds of inactivity, the display starts scrolling.</p>
4	LCD display	Displays system information, status, and error messages or iDRAC IP address.

**Related link**

[Getting help](#)

## Viewing Home screen

The **Home** screen displays user-configurable information about the system. This screen is displayed during normal system operation when there are no status messages or errors. When the system turns off and there are no errors, LCD enters the standby mode after five minutes of inactivity. Press any button on the LCD to turn it on.

- To view the **Home** screen, press one of the three navigation buttons (Select, Left, or Right).
- To navigate to the **Home** screen from another menu, complete the following steps:
  - Press and hold the navigation button till the up arrow  is displayed.
  - Navigate to the **Home** icon  using the up arrow .
  - Select the **Home** icon.
  - On the **Home** screen, press the **Select** button to enter the main menu.

## Setup menu

**NOTE:** When you select an option in the Setup menu, you must confirm the option before proceeding to the next action.

Option	Description
iDRAC	Select <b>DHCP</b> or <b>Static IP</b> to configure the network mode. If <b>Static IP</b> is selected, the available fields are <b>IP</b> , <b>Subnet (Sub)</b> , and <b>Gateway (Gtw)</b> . Select <b>Setup DNS</b> to enable DNS and to view domain addresses. Two separate DNS entries are available.
Set error	Select <b>SEL</b> to view LCD error messages in a format that matches the IPMI description in the SEL. This enables you to match an LCD message with an SEL entry. Select <b>Simple</b> to view LCD error messages in a simplified user-friendly description. For more information about error messages, see the <i>Dell Event and Error Messages Reference Guide</i> at <a href="http://Dell.com/openmanagemanuals">Dell.com/openmanagemanuals</a> > <b>OpenManage software</b> .

Option	Description
Set home	Select the default information to be displayed on the <b>Home</b> screen. See View menu section for the options and option items that can be set as the default on the <b>Home</b> screen.

**Related link**  
[View menu](#)

## View menu

**NOTE:** When you select an option in the View menu, you must confirm the option before proceeding to the next action.

Option	Description
iDRAC IP	Displays the <b>IPv4</b> or <b>IPv6</b> addresses for iDRAC9. Addresses include <b>DNS (Primary and Secondary)</b> , <b>Gateway IP</b> , and <b>Subnet</b> (IPv6 does not have Subnet).
MAC	Displays the MAC addresses for <b>iDRAC</b> , <b>iSCSI</b> , or <b>Network</b> devices.
Name	Displays the name of the <b>Host</b> , <b>Model</b> , or <b>User String</b> for the system.
Number	Displays the <b>Asset tag</b> or the <b>Service tag</b> for the system.
Power	Displays the power output of the system in BTU/hr or Watts. The display format can be configured in the <b>Set home</b> submenu of the <b>Setup</b> menu.
Temperature	Displays the temperature of the system in Celsius or Fahrenheit. The display format can be configured in the <b>Set home</b> submenu of the <b>Setup</b> menu.

## Locating Service Tag of your system

You can identify your system using the unique Express Service Code and Service Tag. Pull out the information tag in front of the system to view the Express Service Code and Service Tag. Alternatively, the information may be on a sticker on the chassis of the system. The mini Enterprise Service Tag (EST) is found on the back of the system. This information is used by Dell to route support calls to the appropriate personnel.

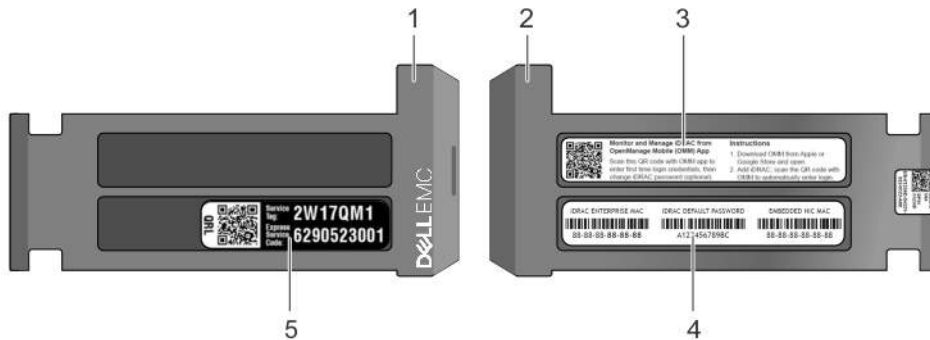

**Figure 15. Locating Service Tag of your system**

- |   |                               |   |   |
|---|-------------------------------|---|---|
| 1 | information tag (top view)    | 2 | information tag (back view)                       |
| 3 | OpenManage Mobile (OMM) label | 4 | iDRAC MAC address and iDRAC secure password label |
| 5 | Service Tag                   |   |   |

## Documentation resources

This section provides information about the documentation resources for your system.

**Table 14. Additional documentation resources for your system**

Task	Document	Location
Setting up your system	For more information about installing and securing the system into a rack, see the rack documentation included with your rack solution.	<a href="http://Dell.com/poweredgemanuals">Dell.com/poweredgemanuals</a>
	For information about setting up and turning on the system, see the <i>Getting Started Guide</i> document that is shipped with your system.	<a href="http://Dell.com/poweredgemanuals">Dell.com/poweredgemanuals</a>
Configuring your system	For information about the iDRAC features, configuring and logging in to iDRAC, and managing your system remotely, see the Integrated Dell Remote Access Controller User's Guide.	<a href="http://Dell.com/idracmanuals">Dell.com/idracmanuals</a>
	For information about installing the operating system, see the operating system documentation.	<a href="http://Dell.com/operatingsystemmanuals">Dell.com/operatingsystemmanuals</a>
	For information about understanding Remote Access Controller Admin (RACADM) subcommands and supported RACADM interfaces, see the RACADM Command Line Reference Guide for iDRAC.	<a href="http://Dell.com/idracmanuals">Dell.com/idracmanuals</a>
	For information about updating drivers and firmware, see the Methods to download firmware and drivers section in this document.	To download drivers: <a href="http://Dell.com/support/drivers">Dell.com/support/drivers</a>
Managing your system	For information about systems management software offered by Dell, see the Dell OpenManage Systems Management Overview Guide.	<a href="http://Dell.com/openmanagemanuals">Dell.com/openmanagemanuals</a>
	For information about setting up, using, and troubleshooting OpenManage, see the Dell OpenManage Server Administrator User's Guide.	<a href="http://Dell.com/openmanagemanuals">Dell.com/openmanagemanuals</a>
	For information about installing, using, and troubleshooting Dell OpenManage Essentials, see the Dell OpenManage Essentials User's Guide.	<a href="http://Dell.com/openmanagemanuals">Dell.com/openmanagemanuals</a>
	For information about installing and using Dell SupportAssist, see the Dell EMC SupportAssist Enterprise User's Guide.	<a href="http://Dell.com/serviceabilitytools">Dell.com/serviceabilitytools</a>
	For understanding the features of Dell Lifecycle Controller, see the Dell Lifecycle Controller User's Guide.	<a href="http://Dell.com/idracmanuals">Dell.com/idracmanuals</a>

Task	Document	Location
Working with the Dell PowerEdge RAID controllers	For information about partner programs enterprise systems management, see the OpenManage Connections Enterprise Systems Management documents.	<a href="http://Dell.com/openmanagemanuals">Dell.com/openmanagemanuals</a>
Understanding event and error messages	For information about understanding the features of the Dell PowerEdge RAID controllers (PERC), Software RAID controllers, or BOSS card and deploying the cards, see the Storage controller documentation.	<a href="http://Dell.com/storagecontrollermanuals">Dell.com/storagecontrollermanuals</a>
Troubleshooting your system	For information about checking the event and error messages generated by the system firmware and agents that monitor system components, see the Dell Event and Error Messages Reference Guide.	<a href="http://Dell.com/openmanagemanuals">Dell.com/openmanagemanuals</a> > <a href="#">OpenManage software</a>
	For information about identifying and troubleshooting the PowerEdge server issues, see the Server Troubleshooting Guide.	<a href="http://Dell.com/poweredgemanuals">Dell.com/poweredgemanuals</a>



# Technical specifications

The technical and environmental specifications of your system are outlined in this section.

Topics:

- System dimensions
- Chassis weight
- Processor specifications
- PSU specifications
- System battery specifications
- Expansion bus specifications
- Memory specifications
- Storage controller specifications
- Drive specifications
- Ports and connectors specifications
- Video specifications
- Environmental specifications

## System dimensions

This section describes the physical dimensions of the system.

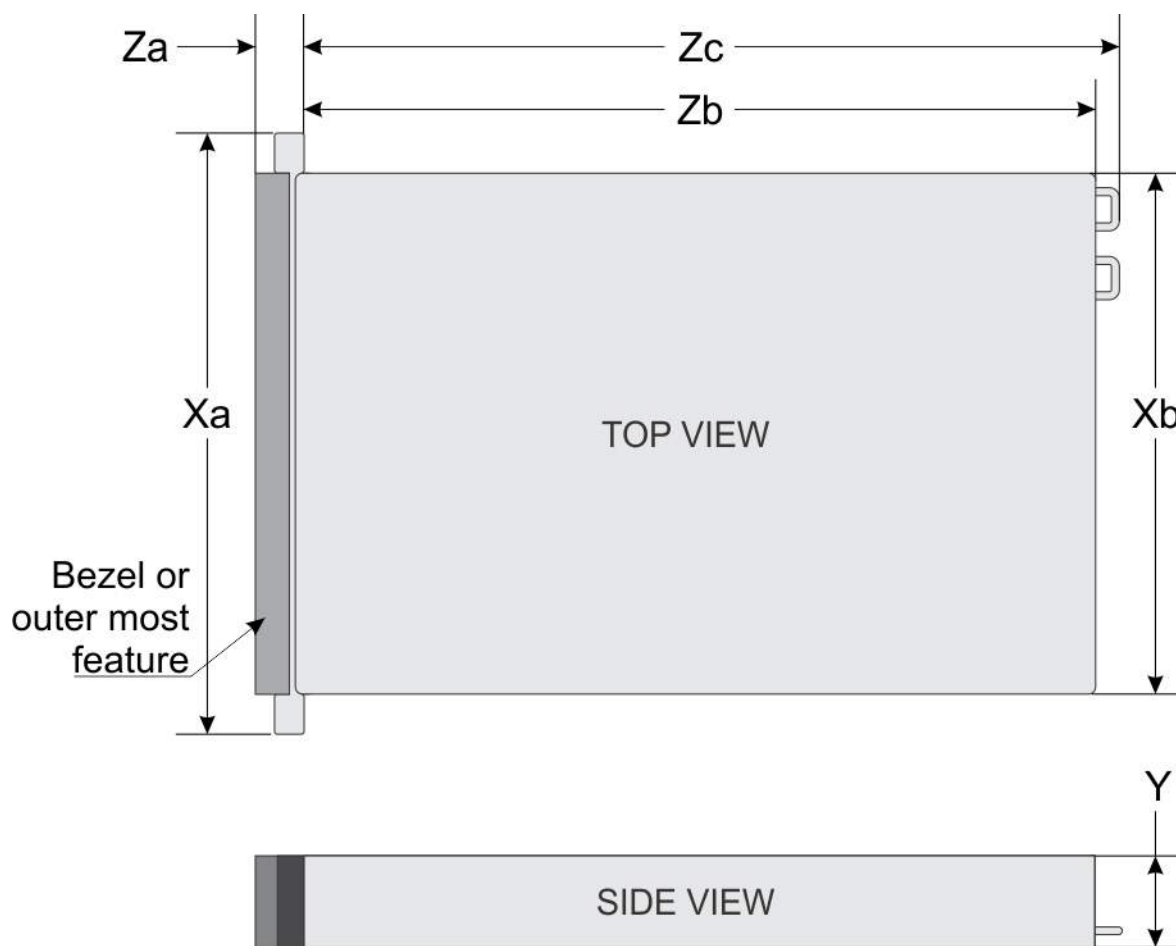

Figure 16. System dimensions of PowerEdge R740xd system

Table 15. Dimensions

System	Xa	Xb	Y	Za (with bezel)	Za (without bezel)	Zb	Zc
PowerEdge R740xd	482.0 mm (18.98 inches)	434.0 mm (17.09 inches)	86.8 mm (3.42 inches)	35.84 mm (1.41 inches)	22.0 mm (0.87 inches)	678.8 mm (26.72 inches)	715.5 mm (28.17 inches)

## Chassis weight

Table 16. Chassis weight

System	Maximum weight (with all drives/SSDs)
2.5 inch drive systems	28.1 kg (61.95 lb)
3.5 inch drive systems	33.1 kg (72.91 lb)

# Processor specifications

The PowerEdge R740xd system supports up to two Intel Xeon Processor Scalable Family processors.

# PSU specifications

The PowerEdge R740xd system supports up to two AC or DC power supply units (PSUs).

**Table 17. PSU specifications**

PSU	Class	Heat dissipation (maximum)	Frequency	Voltage	Current
495 W AC	Platinum	1908 BTU/hr	50/60 Hz	100–240 V AC, autoranging	6.5 A–3 A
750 W AC	Platinum	2891 BTU/hr	50/60 Hz	100–240 V AC, autoranging	10 A–5 A
750 W AC	Titanium	2843 BTU/hr	50/60 Hz	200–240 V AC, autoranging	5 A
750 W Mixed Mode HVDC (for China only)	Platinum	2891 BTU/hr	50/60 Hz	100–240 V AC, autoranging	10 A–5 A
	N/A	2891 BTU/hr	N/A	240 V DC, autoranging	4.5 A
1100 W AC	Platinum	4100 BTU/hr	50/60 Hz	100–240 V AC, autoranging	12 A–6.5 A
1100 W DC	N/A	4416 BTU/hr	N/A	–(48–60) V DC, autoranging	32 A
1100 W Mixed Mode HVDC (for China and Japan only)	Platinum	4100 BTU/hr	50/60 Hz	100–240 V AC, autoranging	12 A–6.5 A
	N/A	4100 BTU/hr	N/A	200–380 V DC, autoranging	6.4 A–3.2 A
1600 W AC	Platinum	6000 BTU/hr	50/60 Hz	100–240 V AC, autoranging	10 A
2000 W AC	Platinum	7500 BTU/hr	50/60 Hz	100–240 V AC, autoranging	11.5 A

**NOTE:** Heat dissipation is calculated using the PSU wattage rating.

**NOTE:** This system is also designed to connect to the IT power systems with a phase to phase voltage not exceeding 240 V.

**NOTE:** If a system with 2000 W AC PSU operates at low line 100–120 V AC, then the power rating per PSU is derated to 1000 W.

**NOTE:** If a system with 1600 W AC PSU operates at low line 100–120 V AC, then the power rating per PSU is derated to 800 W.

**NOTE:** If system with 1100 W AC PSU or 1100 W Mixed Mode HVDC PSU operates at low line 100–120 V AC, then the power rating per PSU is derated to 1050 W.

# System battery specifications

The PowerEdge R740xd system supports CR 2032 3.0-V lithium coin cell system battery.

# Expansion bus specifications

The PowerEdge R740xd system supports up to eight PCI express (PCIe) generation 3 expansion cards that can be installed on the system board using expansion card risers. The following table provides detailed information about the expansion card riser specifications:

**Table 18. Expansion card riser specifications**

Riser configuration and supported risers	Slot description	PCIe slots on riser 1 (Height and length)	Processor connection	PCIe slots on riser 2 (Height and length)	Processor connection	PCIe slots on riser 3 (Height and length)	Processor connection
Riser configuration 0 with or without rear storage (No riser)	No PCIe slots (only rear storage)	N/A	N/A	N/A	N/A	N/A	N/A
Riser configuration 1 with or without rear storage (1B+2B)	Four x8 slots and rear storage	Slot 1: x8 full-height, full length	Processor 1				
		Slot 2: x8 full-height, full length	Processor 1	Slot 4: x8 low profile, half length	Processor 1	N/A	N/A
		Slot 3: x8 full-height, half length	Processor 1				
Riser configuration 2 with or without rear storage (1B+2C)	Three x8 and one x16 slots and rear storage	Slot 1: x8 full-height, full length	Processor 1				
		Slot 2: x8 full-height, full length	Processor 1	Slot 4: x16 low profile, half length	Processor 2	N/A	N/A
		Slot 3: x8 full-height, half length	Processor 1				
Riser configuration 3 (1A+2A)	Two x8 and three x16 slots	Slot 1: x16 full-height, full length	Processor 1	Slot 4: x16 full-height, full length	Processor 2		
		N/A	N/A	Slot 5: x8 full-height, full length	Processor 2	N/A	N/A
		Slot 3: x16 full-height, half length	Processor 1	Slot 6: x8 low profile, half length	Processor 1		
Riser configuration 4 (1A+2A+3A)	Three x8 and four x16 slots	Slot 1: x16 full-height, full length	Processor 1	Slot 4: x16 full-height, full length	Processor 2	Slot 7: x8 full-height, full length	Processor 2
		N/A	N/A	Slot 5: x8 full-height, full length	Processor 2	Slot 8: x16 full-height, full length	Processor 2
		Slot 3: x16 full-height, half length	Processor 1	Slot 6: x8 low profile, half length	Processor 1		
Riser configuration 5 (1B+2A+3A)	Six x8 and two x16 slots	Slot 1: x8 full-height, full length	Processor 1	Slot 4: x16 full-height, full length	Processor 2	Slot 7: x8 full-height, full length	Processor 2
		Slot 2: x8 full-height, full length	Processor 1	Slot 5: x8 full-height, full length	Processor 2	Slot 8: x16 full-height, full length	Processor 2
		Slot 3: x8 full-height, half length	Processor 1	Slot 6: x8 low profile, half length	Processor 1		
Riser configuration 6 (1D+2A+3A)	Five x8 and three x16 slots	Slot 1: x16 full-height, full length	Processor 1	Slot 4: x16 full-height, full length	Processor 2	Slot 7: x8 full-height, full length	Processor 2
		Slot 2: x8 full-height, full length	Processor 1	Slot 5: x8 full-height, full length	Processor 2	Slot 8: x16 full-height, full length	Processor 2

Riser configuration and supported risers	Slot description	PCIe slots on riser 1 (Height and length)	Processor connection	PCIe slots on riser 2 (Height and length)	Processor connection	PCIe slots on riser 3 (Height and length)	Processor connection
Riser configuration 9 (1A+2D+3A)	Three x8 and four x16 slots	Slot 3: x8 full-height, half length	Processor 1	Slot 6: x8 low profile, half length	Processor 1		
		Slot 1: x16 full-height, full length	Processor 1	Slot 4: x16 full-height, full length	Processor 2	Slot 7: x8 full-height, full length	Processor 2
		N/A	N/A	Slot 5: x8 full-height, full length	Processor 2	Slot 8: x16 full-height, full length	Processor 2
		Slot 3: x16 full-height, half length	Processor 1	Slot 6: x8 low profile, half length	Processor 1		

## Memory specifications

The PowerEdge R740xd system supports up to twenty four 288-pins RDIMMS, LRDIMMS and NVDIMM-Ns with speeds of 2666 MT/s, 2400 MT/s and 2133 MT/s with support for memory optimized operation.

Table 19. Memory specifications

DIMM type	DIMM rank	DIMM capacity	Single processor		Dual processors	
			Minimum RAM	Maximum RAM	Minimum RAM	Maximum RAM
LRDIMM	Quad rank	64 GB	64 GB	768 GB	128 GB	1536 GB
RDIMM	Single rank	8 GB	8 GB	96 GB	16 GB	192 GB
RDIMM	Dual rank	16 GB	16 GB	192 GB	32 GB	384 GB
RDIMM	Dual rank	32 GB	32 GB	384 GB	64 GB	768 GB
NVDIMM-N	Single rank	16 GB	Not supported with single processor	Not supported with single processor	RDIMM: 192 GB NVDIMM-N: 16 GB	RDIMM: 384 GB NVDIMM-N: 192 GB

**NOTE:** 8 GB RDIMMs and NVDIMM-N must not be mixed.

**NOTE:** Minimum of two CPUs are required for any configurations that support NVDIMM-N.

## Storage controller specifications

The PowerEdge R740xd system supports:

- Internal storage controller cards: PowerEdge RAID Controller (PERC) H330, PERC H730P, PERC H740P, HBA330, S140, and Boot Optimized Server Storage (BOSS-S1).
- External storage controller cards: PERC H840 and 12Gbps SAS HBA.

## Drive specifications

# Drives

The PowerEdge R740XD system supports SAS, SATA, Nearline SAS hard drives/SSDs, or NVMe drives.

**Table 20. Supported drive options for the PowerEdge R740XD system**

12 drives system	Up to 12 3.5 inch (SAS, SATA or Nearline SAS) front accessible drives in slots 0 to 11
18 drives system	Up to 12 3.5 inch (SAS, SATA or Nearline SAS) front accessible drives in slots 0 to 11, up to four 3.5 inch (SAS, SATA or Nearline SAS) mid drives in slots 14 to 17, and up to two 3.5 inch (SAS, SATA or Nearline SAS) rear accessible drives in slots 12 to 13
20 drives system	Up to 12 3.5 inch (SAS, SATA or Nearline SAS) front accessible drives in slots 0 to 11, up to four 3.5 inch (SAS, SATA or Nearline SAS) mid drives in slots 16 to 19, and up to four 2.5 inch (SAS, SATA or Nearline SAS) rear accessible drives in slots 12 to 15
24 drives system	Up to 24 2.5 inch (SAS, SATA or Nearline SAS) front accessible drives in slots 0 to 23
24 drives system	Up to 12 2.5 inch (SAS, SATA or Nearline SAS) front accessible drives in slots 0 to 11 and up to 12 2.5 inch NVMe drives in 12 universal slots 12 to 23
24 drives system	Up to 24 2.5 inch NVMe drives in bay 1 (slots 0 to 11) and bay 2 (slots 0 to 11)
32 drives system	Up to 24 2.5 inch (SAS, SATA or Nearline SAS) front accessible drives in slots 0 to 23, up to four 2.5 inch (SAS, SATA or Nearline SAS) mid drives in slots 28 to 31, and up to four 2.5 inch (SAS, SATA or Nearline SAS) rear accessible drives in slots 24 to 27

**NOTE:** Universal slots are slots that support SAS, SATA hard drives/SSDs, or NVMe drives in the same slot.

## Ports and connectors specifications

### USB ports

The PowerEdge R740xd system supports:

- Two USB 2.0-compliant ports on the front of the system
- One internal USB 3.0-compliant port
- One micro USB 2.0-compliant port in the front of the system for iDRAC Direct
- Two USB 3.0-compliant ports on the back of the system

### NIC ports

The PowerEdge R740xd system supports up to four Network Interface Controller (NIC) ports that are integrated on the network daughter card (NDC), and are available in the following configurations:

- Four RJ-45 ports that support 10, 100 and 1000 Mbps
- Four RJ-45 ports that support 100 M, 1 G and 10 Gbps
- Four RJ-45 ports, where two ports support maximum of 10 G and the other two ports maximum of 1 G
- Two RJ-45 ports that support up to 1 Gbps and 2 SFP+ ports that support up to 10 Gbps
- Four SFP+ ports that support up to 10 Gbps

- Two SFP28 ports that support up to 25 Gbps

**NOTE:** You can install up to eight PCIe add-on NIC cards.

## VGA ports

The Video Graphic Array (VGA) port enables you to connect the system to a VGA display. The PowerEdge R740xd system supports two 15-pin VGA ports on the front and back panels.

## Serial connector

The PowerEdge R740xd system supports one serial connector on the back panel, which is a 9-pin connector, Data Terminal Equipment (DTE), 16550-compliant.

## Internal Dual SD Module/vFlash card

The PowerEdge R740xd system supports Internal Dual SD module (IDSDM) and vFlash card. In 14th generation of PowerEdge servers, IDSDM and vFlash card are combined into a single card module, and are available in these configurations:

- vFlash or
- IDSDM or
- vFlash and IDSDM

The IDSDM/vFlash card sits in the back of the system, in a Dell-proprietary slot. IDSDM/vFlash card supports three micro SD cards (two cards for IDSDM and one card for vFlash). Micro SD cards capacity for IDSDM are 16/32/64 GB while for vFlash the microSD card capacity is 16 GB.

## Video specifications

The PowerEdge R740xd system supports integrated Matrox G200eW3 graphics controller with 16 MB of video frame buffer.

**Table 21. Supported video resolution options**

Resolution	Refresh rate (Hz)	Color depth (bits)
1024 x 768	60	8, 16, 32
1280 x 800	60	8, 16, 32
1280 x 1024	60	8, 16, 32
1360 x 768	60	8, 16, 32
1440 x 900	60	8, 16, 32
1600 x 900	60	8, 16, 32
1600 x 1200	60	8, 16, 32
1680 x 1050	60	8, 16, 32
1920 x 1080	60	8, 16, 32
1920 x 1200	60	8, 16, 32

NOTE: 1920 x 1080 and 1920 x 1200 resolutions are only supported in reduced blanking mode.

## Environmental specifications

NOTE: For additional information about environmental measurements for specific system configurations, see [Dell.com/environmental\\_datasheets](http://Dell.com/environmental_datasheets).

Table 22. Temperature specifications

Temperature	Specifications
Storage	–40°C to 65°C (–40°F to 149°F)
Continuous operation (for altitude less than 950 m or 3117 ft)	10°C to 35°C (50°F to 95°F) with no direct sunlight on the equipment.
Maximum temperature gradient (operating and storage)	20°C/h (68°F/h)

Table 23. Relative humidity specifications

Relative humidity	Specifications
Storage	5% to 95% RH with 33°C (91°F) maximum dew point. Atmosphere must be non-condensing at all times.
Operating	10% to 80% relative humidity with 29°C (84.2°F) maximum dew point.

Table 24. Maximum vibration specifications

Maximum vibration	Specifications
Operating	0.26 G <sub>rms</sub> at 5 Hz to 350 Hz (all three axes).
Storage	1.88 G <sub>rms</sub> at 10 Hz to 500 Hz for 15 min (all six sides tested).

Table 25. Maximum shock specifications

Maximum shock	Specifications
Operating	Six consecutively executed shock pulses in the positive and negative x, y, and z axes of 6 G for up to 11 ms.
Storage	Six consecutively executed shock pulses in the positive and negative x, y, and z axes (one pulse on each side of the system) of 71 G for up to 2 ms.

Table 26. Maximum altitude specifications

Maximum altitude	Specifications
Operating	3048 m (10,000 ft)
Storage	12,000 m (39,370 ft)



**Table 27. Operating temperature de-rating specifications**

Operating temperature de-rating	Specifications
Up to 35°C (95°F)	Maximum temperature is reduced by 1°C/300 m (1°F/547 ft) above 950 m (3,117 ft).
35°C to 40°C (95°F to 104°F)	Maximum temperature is reduced by 1°C/175 m (1°F/319 ft) above 950 m (3,117 ft).
40°C to 45°C (104°F to 113°F)	Maximum temperature is reduced by 1°C/125 m (1°F/228 ft) above 950 m (3,117 ft).

## Standard operating temperature

**Table 28. Standard operating temperature specifications**

Standard operating temperature	Specifications
Continuous operation (for altitude less than 950 m or 3117 ft)	10°C to 35°C (50°F to 95°F) with no direct sunlight on the equipment.

## Expanded operating temperature

**Table 29. Expanded operating temperature specifications**

Expanded operating temperature	Specifications
Continuous operation	<p>5°C to 40°C at 5% to 85% RH with 29°C dew point.</p> <p><b>NOTE:</b> Outside the standard operating temperature (10°C to 35°C), the system can operate continuously in temperatures as low as 5°C and as high as 40°C.</p> <p>For temperatures between 35°C to 40°C, de-rate maximum allowable temperature by 1°C per 175 m above 950 m (1°F per 319 ft).</p>
≤ 1% of annual operating hours	<p>–5°C to 45°C at 5% to 90% RH with 29°C dew point.</p> <p><b>NOTE:</b> Outside the standard operating temperature (10°C to 35°C), the system can operate down to –5°C or up to 45°C for a maximum of 1% of its annual operating hours.</p> <p>For temperatures between 40°C and 45°C, de-rate maximum allowable temperature by 1°C per 125 m above 950 m (1°F per 228 ft).</p>

**NOTE:** When operating in the expanded temperature range, system performance may be impacted.

**NOTE:** When operating in the expanded temperature range, ambient temperature warnings may be reported in the System Event Log.

## Expanded operating temperature restrictions

- Do not perform a cold startup below 5°C.

- The operating temperature specified is for a maximum altitude of 3050 m (10,000 ft).
- 150 W/8 core, 165 W/12 core and higher wattage processor [Thermal Design Power (TDP)>165 W] are not supported.
- Redundant power supply unit is required.
- Non-Dell qualified peripheral cards and/or peripheral cards greater than 25 W are not supported.
- PCIe SSD is not supported.
- NVDIMM-Ns are not supported.
- Mid drive tray is not supported.
- Rear storage devices or drives are not supported.
- GPU is not supported.
- Tape backup unit is not supported.

## Thermal restrictions

Following table lists the configuration required for efficient cooling.

**Table 30. Thermal restrictions configuration**

Configuration	Number of processors	Heatsink	Processor/DIMM blank	DIMM blanks	Type of air shroud	Fan
PowerEdge R740xd	1	One 1U standard heat sink for CPU $\leq$ 125 W  One 2U standard heat sink for CPU > 125 W	Required	Not required	Standard	Four standard fans and one blank to cover two fan slots
PowerEdge R740xd	2	Two 1U standard heat sink for CPU $\leq$ 125 W  Two 2U standard heat sink for CPU > 125 W	Not required	Not required	Standard	Six standard fans
PowerEdge R740xd with mid bay	1	One 1U high performance heat sink	Required	Required	Not required	Six high performance fans
PowerEdge R740xd with mid bay	2	Two 1U high performance heat sink	Not required	Required	Not required	Six high performance fans
PowerEdge R740xd with GPU	2	Two 1U high performance heat sink	Not required	Not required	GPU air shroud	Six high performance fans

## Ambient temperature limitations

The following table lists configurations that require ambient temperature less than 35°C.

**NOTE:** The ambient temperature limit must be adhered to ensure proper cooling and to avoid excess CPU throttling, which may impact system performance.

**Table 31. Configuration based ambient temperature restrictions**

System	Backplane	CPU Thermal Design Power (TDP)	CPU heat sink	Fan type	GPU	Ambient restriction
PowerEdge R740xd	12 x 3.5 inch SAS/ SATA + 4 x 2.5 inch NVMe + 2 x 3.5 inch	70 W, 85 W, 105 W, 115 W, 125 W, 130 W, 140 W, 150 W, 165 W	1U high performance	High performance fan	N/A	30°C
	12 x 3.5 inch SAS/ SATA + 4 x 2.5 inch NVMe + 2 x 3.5 inch	150 W/8 core, 165 W/12 core, 200 W, 205 W	1U high performance	High performance fan	N/A	25°C
	12 x 3.5 inch SAS/ SATA + 4 x 3.5 inch + 2 x 3.5 inch	150 W/8 core, 165 W/12 core, 200 W, 205 W	1U high performance	High performance fan	N/A	25°C
	24 x 2.5 inch SAS/ SATA + 4 x 2.5 inch + 4 x 2.5 inch	150 W/8 core, 165 W/12 core, 200 W, 205 W	1U high performance	High performance fan	N/A	25°C
	24 x 2.5 inch SAS/ SATA/NVMe with adapter PERC H740P	150 W/8 core, 165 W/12 core, 200 W, 205 W	1U high performance	High performance fan	≥1 double-width/ single-width	30°C

## Particulate and gaseous contamination specifications

The following table defines the limitations that help avoid any equipment damage or failure from particulate and gaseous contamination. If the levels of particulate or gaseous pollution exceed the specified limitations and result in equipment damage or failure, you may need to rectify the environmental conditions. Remediation of environmental conditions is the responsibility of the customer.

**Table 32. Particulate contamination specifications**

Particulate contamination	Specifications
Air filtration	<p>Data center air filtration as defined by ISO Class 8 per ISO 14644-1 with a 95% upper confidence limit.</p> <p><b>NOTE:</b> The ISO Class 8 condition applies to data center environments only. This air filtration requirement does not apply to IT equipment designed to be used outside a data center, in environments such as an office or factory floor.</p> <p><b>NOTE:</b> Air entering the data center must have MERV11 or MERV13 filtration.</p>
Conductive dust	<p>Air must be free of conductive dust, zinc whiskers, or other conductive particles.</p> <p><b>NOTE:</b> This condition applies to data center and non-data center environments.</p>
Corrosive dust	<ul style="list-style-type: none"> <li>Air must be free of corrosive dust.</li> <li>Residual dust present in the air must have a deliquescent point less than 60% relative humidity.</li> </ul>

## Particulate contamination

## Specifications

**NOTE:** This condition applies to data center and non-data center environments.

**Table 33. Gaseous contamination specifications**

### Gaseous contamination

### Specifications

Copper coupon corrosion rate	<300 Å/month per Class G1 as defined by ANSI/ISA71.04-2013.
Silver coupon corrosion rate	<200 Å/month as defined by ANSI/ISA71.04-2013.

**NOTE:** Maximum corrosive contaminant levels measured at ≤50% relative humidity.

# Initial system setup and configuration

## Setting up your system

Complete the following steps to set up your system:

- 1 Unpack the system.
- 2 Install the system into the rack. For more information about installing the system into the rack, see your *Rail Installation Guide* at [Dell.com/poweredgemanuals](http://Dell.com/poweredgemanuals).
- 3 Connect the peripherals to the system.
- 4 Connect the system to its electrical outlet.
- 5 Turn the system on by pressing the power button or by using iDRAC.
- 6 Turn on the attached peripherals.

For more information about setting up your system, see your *Getting Started Guide* shipped with your system.

### Related link

[iDRAC configuration](#)

[Options to set up iDRAC IP address](#)

## iDRAC configuration

The Integrated Dell Remote Access Controller (iDRAC) is designed to make system administrators more productive and improve the overall availability of Dell systems. iDRAC alerts administrators to system issues, helps them perform remote system management, and reduces the need for physical access to the system.

## Options to set up iDRAC IP address

You must configure the initial network settings based on your network infrastructure to enable the communication to and from iDRAC.

You must use the default iDRAC IP address 192.168.0.120 to configure the initial network settings, including setting up DHCP or a static IP for iDRAC. You can set up the IP address by using one of the following interfaces:

Interfaces	Document/Section
iDRAC Settings utility	See <i>Dell Integrated Dell Remote Access Controller User's Guide</i> at <a href="http://Dell.com/idracmanuals">Dell.com/idracmanuals</a>
Dell Deployment Toolkit	See <i>Dell Deployment Toolkit User's Guide</i> at <a href="http://Dell.com/openmanagemanuals">Dell.com/openmanagemanuals</a>
Dell Lifecycle Controller	See <i>Dell Lifecycle Controller User's Guide</i> at <a href="http://Dell.com/idracmanuals">Dell.com/idracmanuals</a>
Chassis or Server LCD panel	See the LCD panel section

## Interfaces Document/Section

iDRAC Direct and Quick Sync 2 (optional) See *Dell Integrated Dell Remote Access Controller User's Guide* at [Dell.com/idracmanuals](https://dell.com/idracmanuals)

**NOTE:** To access iDRAC, ensure that you connect the Ethernet cable to the iDRAC direct port. You can also access iDRAC through the shared LOM mode, if you have opted for a system that has the shared LOM mode enabled.

### Related link

[LCD panel](#)

## Log in to iDRAC

You can log in to iDRAC as:

- iDRAC user
- Microsoft Active Directory user
- Lightweight Directory Access Protocol (LDAP) user

If you have opted for secure default access to iDRAC, the iDRAC secure default password is available on the back of the system Information tag. If you have not opted for secure default access to iDRAC, then the default user name and password are `root` and `calvin`. You can also log in by using Single Sign-On or Smart Card.

**NOTE:** You must have the iDRAC credentials to log in to iDRAC.

**NOTE:** Ensure that you change the default user name and password after setting up the iDRAC IP address.

For more information about logging in to the iDRAC and iDRAC licenses, see the latest *Integrated Dell Remote Access Controller User's Guide* at [Dell.com/idracmanuals](https://dell.com/idracmanuals).

You can also access iDRAC by using RACADM. For more information, see the *RACADM Command Line Interface Reference Guide* at [Dell.com/idracmanuals](https://dell.com/idracmanuals).

## Options to install the operating system

If the system is shipped without an operating system, install the supported operating system by using one of the following resources:

**Table 34. Resources to install the operating system**

Resources	Location
Systems Management Tools and Documentation media	<a href="https://dell.com/operatingsystemmanuals">Dell.com/operatingsystemmanuals</a>
Lifecycle Controller	<a href="https://dell.com/idracmanuals">Dell.com/idracmanuals</a>
OpenManage Deployment Toolkit	<a href="https://dell.com/openmanagemanuals">Dell.com/openmanagemanuals</a>
Dell certified VMware ESXi	<a href="https://dell.com/virtualizationsolutions">Dell.com/virtualizationsolutions</a>
Supported operating systems on PowerEdge systems	<a href="https://dell.com/ossupport">Dell.com/ossupport</a>
Installation and How-to videos for supported operating systems on PowerEdge systems	<a href="#">Supported Operating Systems for Dell PowerEdge Systems</a>

# Methods to download firmware and drivers

You can download the firmware and drivers by using any of the following methods:

**Table 35. Firmware and drivers**

Methods	Location
From the Dell Support site	<a href="https://Dell.com/support/home">Dell.com/support/home</a>
Using Dell Remote Access Controller Lifecycle Controller (iDRAC with LC)	<a href="https://Dell.com/idracmanuals">Dell.com/idracmanuals</a>
Using Dell Repository Manager (DRM)	<a href="https://Dell.com/openmanagemanuals">Dell.com/openmanagemanuals</a>
Using Dell OpenManage Essentials (OME)	<a href="https://Dell.com/openmanagemanuals">Dell.com/openmanagemanuals</a>
Using Dell Server Update Utility (SUU)	<a href="https://Dell.com/openmanagemanuals">Dell.com/openmanagemanuals</a>
Using Dell OpenManage Deployment Toolkit (DTK)	<a href="https://Dell.com/openmanagemanuals">Dell.com/openmanagemanuals</a>

## Downloading drivers and firmware

Dell recommends that you download and install the latest BIOS, drivers, and systems management firmware on your system.

### Prerequisite

Ensure that you clear the web browser cache before downloading the drivers and firmware.

### Steps

- 1 Go to [Dell.com/support/drivers](https://Dell.com/support/drivers).
- 2 In the **Drivers & Downloads** section, type the Service Tag of your system in the **Enter a Service Tag or product ID** box, and then click **Submit**.

**NOTE:** If you do not have the Service Tag, select **Detect Product** to allow the system to automatically detect your Service Tag, or click **View products**, and navigate to your product.

- 3 Click **Drivers & Downloads**.  
The drivers that are applicable to your selection are displayed.
- 4 Download the drivers to a USB drive, CD, or DVD.

# Pre-operating system management applications

You can manage basic settings and features of a system without booting to the operating system by using the system firmware.

Topics:

- [Options to manage the pre-operating system applications](#)
- [System Setup](#)
- [Dell Lifecycle Controller](#)
- [Boot Manager](#)
- [PXE boot](#)

## Options to manage the pre-operating system applications

Your system has the following options to manage the pre-operating system applications:

- System Setup
- Dell Lifecycle Controller
- Boot Manager
- Preboot Execution Environment (PXE)

### Related link

- [System Setup](#)
- [Dell Lifecycle Controller](#)
- [Boot Manager](#)
- [PXE boot](#)

## System Setup

By using the **System Setup** screen, you can configure the BIOS settings, iDRAC settings, and device settings of your system.

**NOTE:** Help text for the selected field is displayed in the graphical browser by default. To view the help text in the text browser, press F1.

You can access system setup by using two methods:

- Standard graphical browser—The browser is enabled by default.
- Text browser—The browser is enabled by using Console Redirection.

### Related link

- [System Setup details](#)
- [Viewing System Setup](#)



# Viewing System Setup

To view the **System Setup** screen, perform the following steps:

- 1 Turn on, or restart your system.
- 2 Press F2 immediately after you see the following message:

F2 = System Setup

**NOTE:** If your operating system begins to load before you press F2, wait for the system to finish booting, and then restart your system and try again.

## Related link

[System Setup](#)

[System Setup details](#)

# System Setup details

The **System Setup Main Menu** screen details are explained as follows:

Option	Description
<b>System BIOS</b>	Enables you to configure BIOS settings.
<b>iDRAC Settings</b>	Enables you to configure the iDRAC settings. The iDRAC settings utility is an interface to set up and configure the iDRAC parameters by using UEFI (Unified Extensible Firmware Interface). You can enable or disable various iDRAC parameters by using the iDRAC settings utility. For more information about this utility, see <i>Integrated Dell Remote Access Controller User's Guide</i> at <a href="http://Dell.com/idracmanuals">Dell.com/idracmanuals</a> .
<b>Device Settings</b>	Enables you to configure device settings.

## Related link

[System Setup](#)

[iDRAC Settings utility](#)

[Device Settings](#)

[Viewing System Setup](#)

# System BIOS

You can use the **System BIOS** screen to edit specific functions such as boot order, system password, setup password, set the SATA and PCIe NVMe RAID mode, and enable or disable USB ports.

## Related link

- [System BIOS Settings details](#)
- [Boot Settings](#)
- [Network Settings](#)
- [System Information](#)
- [Memory Settings](#)
- [Processor Settings](#)
- [SATA Settings](#)
- [Integrated Devices](#)
- [Serial Communication](#)
- [System Profile Settings](#)
- [Miscellaneous Settings](#)
- [iDRAC Settings utility](#)
- [Device Settings](#)
- [System Security](#)
- [Viewing System BIOS](#)

## Viewing System BIOS

To view the **System BIOS** screen, perform the following steps:

- 1 Turn on, or restart your system.
- 2 Press F2 immediately after you see the following message:

F2 = System Setup

**NOTE:** If your operating system begins to load before you press F2, wait for the system to finish booting, and then restart your system and try again.

- 3 On the **System Setup Main Menu** screen, click **System BIOS**.

## System BIOS Settings details

The **System BIOS Settings** screen details are explained as follows:

Option	Description
<b>System Information</b>	Specifies information about the system such as the system model name, BIOS version, and Service Tag.
<b>Memory Settings</b>	Specifies information and options related to the installed memory.
<b>Processor Settings</b>	Specifies information and options related to the processor such as speed and cache size.
<b>SATA Settings</b>	Specifies options to enable or disable the integrated SATA controller and ports.
<b>NVMe Settings</b>	Specifies options to change the NVMe settings. If the system contains the NVMe drives that you want to configure in a RAID array, you must set both this field and the <b>Embedded SATA</b> field on the <b>SATA Settings</b> menu to <b>RAID</b> mode. You might also need to change the <b>Boot Mode</b> setting to <b>UEFI</b> . Otherwise, you should set this field to <b>Non-RAID</b> mode.
<b>Boot Settings</b>	Specifies options to specify the Boot mode (BIOS or UEFI). Enables you to modify UEFI and BIOS boot settings.

Option	Description
<b>Network Settings</b>	Specifies options to manage the UEFI network settings and boot protocols. Legacy network settings are managed from the <b>Device Settings</b> menu.
<b>Integrated Devices</b>	Specifies options to manage integrated device controllers and ports, specifies related features and options.
<b>Serial Communication</b>	Specifies options to manage the serial ports, its related features and options.
<b>System Profile Settings</b>	Specifies options to change the processor power management settings, memory frequency.
<b>System Security</b>	Specifies options to configure the system security settings, such as system password, setup password, Trusted Platform Module (TPM) security, and UEFI secure boot. It also manages the power button on the system.
<b>Redundant OS Control</b>	Sets the redundant OS info for redundant OS control.
<b>Miscellaneous Settings</b>	Specifies options to change the system date and time.

## System Information

You can use the **System Information** screen to view system properties such as Service Tag, system model name, and the BIOS version.

## Viewing System Information

To view the **System Information** screen, perform the following steps:

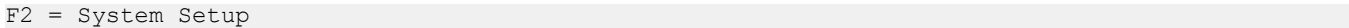
- 1 Turn on, or restart your system.
- 2 Press F2 immediately after you see the following message:  

- 3 On the **System Setup Main Menu** screen, click **System BIOS**.
- 4 On the **System BIOS** screen, click **System Information**.

**NOTE:** If your operating system begins to load before you press F2, wait for the system to finish booting, and then restart your system and try again.

## System Information details

The **System Information** screen details are explained as follows:

Option	Description
<b>System Model Name</b>	Specifies the system model name.
<b>System BIOS Version</b>	Specifies the BIOS version installed on the system.
<b>System Management Engine Version</b>	Specifies the current version of the Management Engine firmware.
<b>System Service Tag</b>	Specifies the system Service Tag.

Option	Description
<b>System Manufacturer</b>	Specifies the name of the system manufacturer.
<b>System Manufacturer Contact Information</b>	Specifies the contact information of the system manufacturer.
<b>System CPLD Version</b>	Specifies the current version of the system complex programmable logic device (CPLD) firmware.
<b>UEFI Compliance Version</b>	Specifies the UEFI compliance level of the system firmware.

## Memory Settings

You can use the **Memory Settings** screen to view all the memory settings and enable or disable specific memory functions, such as system memory testing and node interleaving.

### Viewing Memory Settings

To view the **Memory Settings** screen, perform the following steps:

- 1 Turn on, or restart your system.
- 2 Press F2 immediately after you see the following message:

F2 = System Setup

**NOTE:** If your operating system begins to load before you press F2, wait for the system to finish booting, and then restart your system and try again.

- 3 On the **System Setup Main Menu** screen, click **System BIOS**.
- 4 On the **System BIOS** screen, click **Memory Settings**.

### Memory Settings details

The **Memory Settings** screen details are explained as follows:

Option	Description
<b>System Memory Size</b>	Specifies the memory size in the system.
<b>System Memory Type</b>	Specifies the type of memory installed in the system.
<b>System Memory Speed</b>	Specifies the system memory speed.
<b>System Memory Voltage</b>	Specifies the system memory voltage.
<b>Video Memory</b>	Specifies the amount of video memory.
<b>System Memory Testing</b>	Specifies whether the system memory tests are run during system boot. Options are <b>Enabled</b> and <b>Disabled</b> . This option is set to <b>Disabled</b> by default.
<b>Memory Operating Mode</b>	Specifies the memory operating mode. The options available are <b>Optimizer Mode</b> , <b>Single Rank Spare Mode</b> , <b>Multi Rank Spare Mode</b> , <b>Mirror Mode</b> , and <b>Dell Fault Resilient Mode</b> . This option is set to <b>Optimizer Mode</b> by default.

Option	Description
	<p>① <b>NOTE:</b> The <b>Memory Operating Mode</b> option can have different default and available options based on the memory configuration of your system.</p> <p>① <b>NOTE:</b> The <b>Dell Fault Resilient Mode</b> option establishes an area of memory that is fault resilient. This mode can be used by an operating system that supports the feature to load critical applications or enables the operating system kernel to maximize system availability.</p>
<b>Current State of Memory Operating Mode</b>	Specifies the current state of the memory operating mode.
<b>Node Interleaving</b>	Specifies if Non-Uniform Memory Architecture (NUMA) is supported. If this field is set to <b>Enabled</b> , memory interleaving is supported if a symmetric memory configuration is installed. If the field is set to <b>Disabled</b> , the system supports NUMA (asymmetric) memory configurations. This option is set to <b>Disabled</b> by default.
<b>Opportunistic Self-Refresh</b>	Enables or disables opportunistic self-refresh feature. This option is set to <b>Disabled</b> by default.
<b>Persistent Memory</b>	This field controls Persistent Memory on the system.

## Persistent Memory details

The **Persistent Memory** screen details can be found in the *NVDIMM-N User Guide* at [Dell.com/poweredgemanuals](http://Dell.com/poweredgemanuals).

## Processor Settings

You can use the **Processor Settings** screen to view the processor settings, and perform specific functions such as enabling virtualization technology, hardware prefetcher, logical processor idling, and opportunistic self-refresh.

## Viewing Processor Settings

To view the **Processor Settings** screen, perform the following steps:

- 1 Turn on, or restart your system.
- 2 Press F2 immediately after you see the following message:

F2 = System Setup



① **NOTE:** If your operating system begins to load before you press F2, wait for the system to finish booting, and then restart your system and try again.

- 3 On the **System Setup Main Menu** screen, click **System BIOS**.
- 4 On the **System BIOS** screen, click **Processor Settings**.

## Processor Settings details

The **Processor Settings** screen details are explained as follows:

Option	Description
<b>Logical Processor</b>	Enables or disables the logical processors and displays the number of logical processors. If this option is set to <b>Enabled</b> , the BIOS displays all the logical processors. If this option is set to <b>Disabled</b> , the BIOS displays only one logical processor per core. This option is set to <b>Enabled</b> by default.
<b>CPU Interconnect Speed</b>	Enables you to govern the frequency of the communication links among the CPUs in the system.

Option	Description				
	<p>   <b>NOTE: The standard and basic bin processors support lower link frequencies.</b></p> <p>The options available are <b>Maximum data rate, 10.4 GT/s</b>, and <b>9.6 GT/s</b>. This option is set to <b>Maximum data rate</b> by default.</p> <p>Maximum data rate indicates that the BIOS runs the communication links at the maximum frequency supported by the processors. You can also select specific frequencies that the processors support, which can vary.</p> <p>For best performance, you should select <b>Maximum data rate</b>. Any reduction in the communication link frequency affects the performance of non-local memory accesses and cache coherency traffic. In addition, it can slow access to non-local I/O devices from a particular CPU.</p> <p>However, if power saving considerations outweigh performance, you might want to reduce the frequency of the CPU communication links. If you do this, you should localize memory and I/O accesses to the nearest NUMA node to minimize the impact to system performance.</p>				
<b>Virtualization Technology</b>	Enables or disables the virtualization technology for the processor. This option is set to <b>Enabled</b> by default.				
<b>Adjacent Cache Line Prefetch</b>	Optimizes the system for applications that need high utilization of sequential memory access. This option is set to <b>Enabled</b> by default. You can disable this option for applications that need high utilization of random memory access.				
<b>Hardware Prefetcher</b>	Enables or disables the hardware prefetcher. This option is set to <b>Enabled</b> by default.				
<b>DCU Streamer Prefetcher</b>	Enables or disables the Data Cache Unit (DCU) streamer prefetcher. This option is set to <b>Enabled</b> by default.				
<b>DCU IP Prefetcher</b>	Enables or disables the Data Cache Unit (DCU) IP prefetcher. This option is set to <b>Enabled</b> by default.				
<b>Sub NUMA Cluster</b>	Enables or disables the Sub NUMA Cluster. This option is set to <b>Disabled</b> by default.				
<b>UPI Prefetch</b>	Enables you to get the memory read started early on DDR bus. The Ultra Path Interconnect (UPI) Rx path will spawn the speculative memory read to Integrated Memory Controller (iMC) directly. This option is set to <b>Enabled</b> by default.				
<b>Logical Processor Idling</b>	Enables you to improve the energy efficiency of a system. It uses the operating system core parking algorithm and parks some of the logical processors in the system which in turn allows the corresponding processor cores to transition into a lower power idle state. This option can only be enabled if the operating system supports it. It is set to <b>Disabled</b> by default.				
<b>x2APIC Mode</b>	Enables or disables the x2APIC mode. This option is set to <b>Disabled</b> by default.				
<b>Dell Controlled Turbo</b>	Controls the turbo engagement. Enable this option only when <b>System Profile</b> is set to <b>Performance</b> .    <b>NOTE: Depending on the number of installed CPUs, there might be up to four processor listings.</b>				
<b>Number of Cores per Processor</b>	Controls the number of enabled cores in each processor. This option is set to <b>All</b> by default.				
<b>Processor Core Speed</b>	Specifies the maximum core frequency of the processor.				
<b>Processor n</b>	<p>   <b>NOTE: Depending on the number of CPUs, there might be up to four processors listed.</b></p> <p>The following settings are displayed for each processor installed in the system:</p> <table border="1"> <thead> <tr> <th>Option</th> <th>Description</th> </tr> </thead> <tbody> <tr> <td><b>Family-Model-Stepping</b></td> <td>Specifies the family, model, and stepping of the processor as defined by Intel.</td> </tr> </tbody> </table>	Option	Description	<b>Family-Model-Stepping</b>	Specifies the family, model, and stepping of the processor as defined by Intel.
Option	Description				
<b>Family-Model-Stepping</b>	Specifies the family, model, and stepping of the processor as defined by Intel.				

Option	Description
<b>Option</b>	<b>Description</b>
<b>Brand</b>	Specifies the brand name.
<b>Level 2 Cache</b>	Specifies the total L2 cache.
<b>Level 3 Cache</b>	Specifies the total L3 cache.
<b>Number of Cores</b>	Specifies the number of cores per processor.

## SATA Settings

You can use the **SATA Settings** screen to view the SATA settings of SATA devices and enable SATA and PCIe NVMe RAID mode on your system.

### Viewing SATA Settings

To view the **SATA Settings** screen, perform the following steps:

- 1 Turn on, or restart your system.
- 2 Press F2 immediately after you see the following message:

F2 = System Setup

**NOTE:** If your operating system begins to load before you press F2, wait for the system to finish booting, and then restart your system and try again.

- 3 On the **System Setup Main Menu** screen, click **System BIOS**.
- 4 On the **System BIOS** screen, click **SATA Settings**.

### SATA Settings details

The **SATA Settings** screen details are explained as follows:

Option	Description								
<b>Embedded SATA</b>	Enables the embedded SATA option to be set to <b>Off</b> , <b>AHCI</b> , or <b>RAID</b> modes. This option is set to <b>AHCI Mode</b> by default.								
<b>Security Freeze Lock</b>	Sends <b>Security Freeze Lock</b> command to the embedded SATA drives during POST. This option is applicable only for AHCI Mode. This option is set to <b>Enabled</b> by default.								
<b>Write Cache</b>	Enables or disables the command for the embedded SATA drives during POST. This option is set to <b>Disabled</b> by default.								
<b>Port n</b>	Sets the drive type of the selected device. For <b>AHCI Mode</b> or <b>RAID Mode</b> , BIOS support is always enabled.								
	<table border="1"> <thead> <tr> <th>Option</th> <th>Description</th> </tr> </thead> <tbody> <tr> <td><b>Model</b></td> <td>Specifies the drive model of the selected device.</td> </tr> <tr> <td><b>Drive Type</b></td> <td>Specifies the type of drive attached to the SATA port.</td> </tr> <tr> <td><b>Capacity</b></td> <td>Specifies the total capacity of the drive. This field is undefined for removable media devices such as optical drives.</td> </tr> </tbody> </table>	Option	Description	<b>Model</b>	Specifies the drive model of the selected device.	<b>Drive Type</b>	Specifies the type of drive attached to the SATA port.	<b>Capacity</b>	Specifies the total capacity of the drive. This field is undefined for removable media devices such as optical drives.
Option	Description								
<b>Model</b>	Specifies the drive model of the selected device.								
<b>Drive Type</b>	Specifies the type of drive attached to the SATA port.								
<b>Capacity</b>	Specifies the total capacity of the drive. This field is undefined for removable media devices such as optical drives.								

# Boot Settings

You can use the **Boot Settings** screen to set the boot mode to either **BIOS** or **UEFI**. It also enables you to specify the boot order.

- **UEFI:** The Unified Extensible Firmware Interface (UEFI) is a new interface between operating systems and platform firmware. The interface consists of data tables with platform related information, also boot and runtime service calls that are available to the operating system and its loader. The following benefits are available when the **Boot Mode** is set to **UEFI**:
  - Support for drive partitions larger than 2 TB.
  - Enhanced security (e.g., UEFI Secure Boot).
  - Faster boot time.
- **BIOS:** The **BIOS Boot Mode** is the legacy boot mode. It is maintained for backward compatibility.

**NOTE:** You must use only the UEFI boot mode in order to boot from NVMe drives.

## Viewing Boot Settings

To view the **Boot Settings** screen, perform the following steps:

- 1 Turn on, or restart your system.
- 2 Press F2 immediately after you see the following message:  
F2 = System Setup

**NOTE:** If your operating system begins to load before you press F2, wait for the system to finish booting, and then restart your system and try again.



- 3 On the **System Setup Main Menu** screen, click **System BIOS**.
- 4 On the **System BIOS** screen, click **Boot Settings**.

## Boot Settings details

The **Boot Settings** screen details are explained as follows:

Option	Description
<b>Boot Mode</b>	<p>Enables you to set the boot mode of the system.</p> <p><b>CAUTION:</b> Switching the boot mode may prevent the system from booting if the operating system is not installed in the same boot mode.</p> <p>If the operating system supports <b>UEFI</b>, you can set this option to <b>UEFI</b>. Setting this field to <b>BIOS</b> allows compatibility with non-UEFI operating systems. This option is set to <b>UEFI</b> by default.</p> <p><b>NOTE:</b> Setting this field to UEFI disables the BIOS Boot Settings menu.</p>
<b>Boot Sequence Retry</b>	<p>Enables or disables the <b>Boot Sequence Retry</b> feature. If this option is set to <b>Enabled</b> and the system fails to boot, the system re-attempts the boot sequence after 30 seconds. This option is set to <b>Enabled</b> by default.</p>
<b>Hard-Disk Failover</b>	<p>Specifies the drive that is booted in the event of a drive failure. The devices are selected in the <b>Hard-Disk Drive Sequence</b> on the <b>Boot Option Setting</b> menu. When this option is set to <b>Disabled</b>, only the first drive in the list is attempted to boot. When this option is set to <b>Enabled</b>, all drives are attempted to boot in the order selected in the <b>Hard-Disk Drive Sequence</b>. This option is not enabled for <b>UEFI Boot Mode</b>. This option is set to <b>Disabled</b> by default.</p>
<b>Boot Option Settings</b>	<p>Configures the boot sequence and the boot devices.</p>
<b>BIOS Boot Settings</b>	<p>Enables or disables BIOS boot options.</p>



Option	Description
	   <b>NOTE:</b> This option is enabled only if the boot mode is BIOS.
<b>UEFI Boot Settings</b>	Enables or disables UEFI Boot options.    <b>NOTE:</b> This option is enabled only if the boot mode is UEFI.

## Choosing system boot mode

System Setup enables you to specify one of the following boot modes for installing your operating system:

- BIOS boot mode is the standard BIOS-level boot interface.
- UEFI boot mode (the default), is an enhanced 64-bit boot interface.

- 1 From the **System Setup Main Menu**, click **Boot Settings**, and select **Boot Mode**.
- 2 Select the UEFI boot mode you want the system to boot into.

 **CAUTION:** Switching the boot mode may prevent the system from booting if the operating system is not installed in the same boot mode.

- 3 After the system boots in the specified boot mode, proceed to install your operating system from that mode.

 **NOTE:** Operating systems must be UEFI-compatible to be installed from the UEFI boot mode. DOS and 32-bit operating systems do not support UEFI and can only be installed from the BIOS boot mode.

 **NOTE:** For the latest information about supported operating systems, go to [Dell.com/ossupport](http://Dell.com/ossupport).

## Changing boot order

### About this task

You may have to change the boot order if you want to boot from a USB key or an optical drive. The following instructions may vary if you have selected **BIOS** for **Boot Mode**.

### Steps

- 1 On the **System Setup Main Menu** screen, click **System BIOS > Boot Settings > UEFI/BIOS Boot Settings > UEFI/BIOS Boot Sequence**.
- 2 Use the arrow keys to select a boot device, and use the plus (+) and minus (-) sign keys to move the device down or up in the order.
- 3 Click **Exit**, and then click **Yes** to save the settings on exit.

## Network Settings

You can use the **Network Settings** screen to modify UEFI PXE, iSCSI, and HTTP boot settings. The network settings option is available only in the UEFI mode.

 **NOTE:** The BIOS does not control network settings in the BIOS mode. For the BIOS boot mode, the option ROM of the network controllers handles the network settings.

## Viewing Network Settings

To view the **Network Settings** screen, perform the following steps:

- 1 Turn on, or restart your system.
- 2 Press F2 immediately after you see the following message:

F2 = System Setup

**NOTE:** If your operating system begins to load before you press F2, wait for the system to finish booting, and then restart your system and try again.

- 3 On the **System Setup Main Menu** screen, click **System BIOS**.
- 4 On the **System BIOS** screen, click **Network Settings**.

## Network Settings screen details

The **Network Settings** screen details are explained as follows:

Option	Description
<b>PXE Device n</b> (n = 1 to 4)	Enables or disables the device. When enabled, a UEFI PXE boot option is created for the device.
<b>PXE Device n Settings</b> (n = 1 to 4)	Enables you to control the configuration of the PXE device.
<b>HTTP Device n</b> (n = 1 to 4)	Enables or disables the device. When enabled, a UEFI HTTP boot option is created for the device.
<b>HTTP Device n Settings</b> (n = 1 to 4)	Enables you to control the configuration of the HTTP device.

## UEFI iSCSI Settings

You can use the iSCSI Settings screen to modify iSCSI device settings. The iSCSI Settings option is available only in the UEFI boot mode. BIOS does not control network settings in the BIOS boot mode. For the BIOS boot mode, the option ROM of the network controller handles the network settings.

## Viewing UEFI iSCSI Settings

To view the **UEFI iSCSI Settings** screen, perform the following steps:

- 1 Turn on, or restart your system.
- 2 Press F2 immediately after you see the following message:

F2 = System Setup

**NOTE:** If your operating system begins to load before you press F2, wait for the system to finish booting, and then restart your system and try again.

- 3 On the **System Setup Main Menu** screen, click **System BIOS**.
- 4 On the **System BIOS** screen, click **Network Settings**.
- 5 On the **Network Settings** screen, click **UEFI iSCSI Settings**.

## UEFI iSCSI Settings details

The **UEFI iSCSI Settings** screen details are explained as follows:

Option	Description
<b>iSCSI Initiator Name</b>	Specifies the name of the iSCSI initiator (iqn format).
<b>iSCSI Device1</b>	Enables or disables the iSCSI device. When disabled, a UEFI boot option is created for the iSCSI device automatically.
<b>iSCSI Device1 Settings</b>	Enables you to control the configuration of the iSCSI device.

## Integrated Devices

You can use the **Integrated Devices** screen to view and configure the settings of all integrated devices including the video controller, integrated RAID controller, and the USB ports.

## Viewing Integrated Devices

To view the **Integrated Devices** screen, perform the following steps:

- 1 Turn on, or restart your system.
- 2 Press F2 immediately after you see the following message:

F2 = System Setup



**NOTE:** If your operating system begins to load before you press F2, wait for the system to finish booting, and then restart your system and try again.

- 3 On the **System Setup Main Menu** screen, click **System BIOS**.
- 4 On the **System BIOS** screen, click **Integrated Devices**.

## Integrated Devices details

The **Integrated Devices** screen details are explained as follows:

Option	Description
<b>User Accessible USB Ports</b>	Configures the user accessible USB ports. Selecting <b>Only Back Ports On</b> disables the front USB ports; selecting <b>All Ports Off</b> disables all front and back USB ports; selecting <b>All Ports Off (Dynamic)</b> disables all front and back USB ports during POST and front ports can be enabled or disabled dynamically by authorized user without resetting the system.  The USB keyboard and mouse still function in certain USB ports during the boot process, depending on the selection. After the boot process is complete, the USB ports will be enabled or disabled as per the setting.
<b>Internal USB Port</b>	Enables or disables the internal USB port. This option is set to <b>Enabled</b> by default.
<b>Integrated RAID Controller</b>	Enables or disables the integrated RAID controller. This option is set to <b>Enabled</b> by default.
<b>Integrated Network Card 1</b>	Enables or disables the integrated network card (NDC). When set to <b>Disabled</b> , the NDC is not available to the operating system (OS). This option is set to <b>Enable</b> by default.

Option	Description
	<p> <b>NOTE: If set to Disabled (OS), the Integrated NICs might still be available for shared network access by iDRAC.</b></p>
<b>I/OAT DMA Engine</b>	Enables or disables the I/O Acceleration Technology (I/OAT) option. I/OAT is a set of DMA features designed to accelerate network traffic and lower CPU utilization. Enable only if the hardware and software support the feature.
<b>Embedded Video Controller</b>	<p>Enables or disables the use of Embedded Video Controller as the primary display. When set to <b>Enabled</b>, the Embedded Video Controller will be the primary display even if add-in graphic cards are installed. When set to <b>Disabled</b>, an add-in graphics card will be used as the primary display. BIOS will output displays to both the primary add-in video and the embedded video during POST and pre-boot environment. The embedded video will then be disabled right before the operating system boots. This option is set to <b>Enabled</b> by default.</p> <p> <b>NOTE: When there are multiple add-in graphic cards installed in the system, the first card discovered during PCI enumeration is selected as the primary video. You might have to re-arrange the cards in the slots in order to control which card is the primary video.</b></p>
<b>Current State of Embedded Video Controller</b>	Displays the current state of the embedded video controller. The <b>Current State of Embedded Video Controller</b> option is a read-only field. If the Embedded Video Controller is the only display capability in the system (that is, no add-in graphics card is installed), then the Embedded Video Controller is automatically used as the primary display even if the <b>Embedded Video Controller</b> setting is set to <b>Disabled</b> .
<b>SR-IOV Global Enable</b>	Enables or disables the BIOS configuration of Single Root I/O Virtualization (SR-IOV) devices. This option is set to <b>Disabled</b> by default.
<b>Internal SD Card Port</b>	Enables or disables the internal SD card port of the Internal Dual SD Module (IDSDM). This option is set to <b>On</b> by default.
<b>Internal SD Card Redundancy</b>	<p>Configures the redundancy mode of the Internal Dual SD Module (IDSDM). When set to <b>Mirror Mode</b>, data is written on both SD cards. After failure of either card and replacement of the failed card, the data of the active card is copied to the offline card during the system boot.</p> <p>When Internal SD Card Redundancy is set to <b>Disabled</b>, only the primary SD card is visible to the OS. This option is set to <b>Disabled</b> by default.</p>
<b>Internal SD Primary Card</b>	When <b>Redundancy</b> is set to <b>Disabled</b> , either one of the SD card can be selected to present itself as mass storage device by setting it to be primary card. By default primary SD card is selected to be SD Card 1. If SD Card 1 is not present, then the controller will select SD Card 2 to be the primary SD card.
<b>OS Watchdog Timer</b>	If your system stops responding, this watchdog timer aids in the recovery of your operating system. When this option is set to <b>Enabled</b> , the operating system initializes the timer. When this option is set to <b>Disabled</b> (the default), the timer does not have any effect on the system.
<b>Memory Mapped I/O above 4 GB</b>	Enables or disables the support for the PCIe devices that need large amounts of memory. Enable this option only for 64-bit operating systems. This option is set to <b>Enabled</b> by default.
<b>Memory Mapped I/O above Base</b>	When set to <b>12 TB</b> , the system will map MMIO base to 12 TB. Enable this option for an OS that requires 44 bit PCIe addressing. When set to <b>512 GB</b> , the system will map MMIO base to 512 GB, and reduce the maximum support for memory to less than 512 GB. Enable this option only for the 4 GPU DGMA issue. This option is set to <b>56 TB</b> by default.
<b>Slot Disablement</b>	Enables or disables the available PCIe slots on your system. The slot disablement feature controls the configuration of the PCIe cards installed in the specified slot. Slots must be disabled only when the installed peripheral card prevents booting into the operating system or causes delays in system startup. If the slot is disabled, both the Option ROM and UEFI drivers are disabled. Only slots that are present on the system will be available for control.
<b>Slot Bifurcation</b>	Allows <b>Platform Default Bifurcation</b> , <b>Auto discovery of Bifurcation</b> and <b>Manual bifurcation Control</b> . The default is set to <b>Platform Default Bifurcation</b> . The slot bifurcation field is accessible when set to <b>Manual bifurcation Control</b> and is grayed out when set to <b>Platform Default Bifurcation</b> or <b>Auto discovery of Bifurcation</b> .

Option	Description
--------	-------------

**Table 36. Slot Bifurcation**

Option	Description
<b>Slot 1 Bifurcation</b>	X4 or X8 or X4X4X4X8 or X8X4X4 Bifurcation
<b>Slot 3 Bifurcation</b>	X4 or X8 or X4X4X4X8 or X8X4X4 Bifurcation
<b>Slot 4 Bifurcation</b>	X16 or X4 or X8 or X4X4X4X8 or X8X4X4 Bifurcation
<b>Slot 5 Bifurcation</b>	X4 Bifurcation or X8 Bifurcation

## Serial Communication

You can use the **Serial Communication** screen to view the properties of the serial communication port.

### Viewing Serial Communication

To view the **Serial Communication** screen, perform the following steps:

- 1 Turn on, or restart your system.
- 2 Press F2 immediately after you see the following message:

F2 = System Setup

**NOTE:** If your operating system begins to load before you press F2, wait for the system to finish booting, and then restart your system and try again.

- 3 On the **System Setup Main Menu** screen, click **System BIOS**.
- 4 On the **System BIOS** screen, click **Serial Communication**.

### Serial Communication details

The **Serial Communication** screen details are explained as follows:

Option	Description
<b>Serial Communication</b>	Selects serial communication devices (Serial Device 1 and Serial Device 2) in BIOS. BIOS console redirection can also be enabled, and the port address can be specified. This option is set to <b>Auto</b> by default.
<b>Serial Port Address</b>	Enables you to set the port address for serial devices. This option is set to <b>Serial Device1=COM2, Serial Device 2=COM1</b> by default. <ul style="list-style-type: none"> <li><b>NOTE:</b> You can use only Serial Device 2 for the Serial Over LAN (SOL) feature. To use console redirection by SOL, configure the same port address for console redirection and the serial device.</li> <li><b>NOTE:</b> Every time the system boots, the BIOS syncs the serial MUX setting saved in iDRAC. The serial MUX setting can independently be changed in iDRAC. Loading the BIOS default settings from within the BIOS setup utility may not always revert the serial MUX setting to the default setting of Serial Device 1.</li> </ul>

Option	Description
<b>External Serial Connector</b>	<p>Enables you to associate the External Serial Connector to <b>Serial Device 1</b>, <b>Serial Device 2</b>, or the <b>Remote Access Device</b> by using this option. This option is set to <b>Serial Device 1</b> by default.</p> <p><b>NOTE:</b> Only Serial Device 2 can be used for Serial Over LAN (SOL). To use console redirection by SOL, configure the same port address for console redirection and the serial device.</p> <p><b>NOTE:</b> Every time the system boots, the BIOS syncs the serial MUX setting saved in iDRAC. The serial MUX setting can independently be changed in iDRAC. Loading the BIOS default settings from within the BIOS setup utility may not always revert this setting to the default setting of Serial Device 1.</p>
<b>Failsafe Baud Rate</b>	Specifies the failsafe baud rate for console redirection. The BIOS attempts to determine the baud rate automatically. This failsafe baud rate is used only if the attempt fails, and the value must not be changed. This option is set to <b>115200</b> by default.
<b>Remote Terminal Type</b>	Sets the remote console terminal type. This option is set to <b>VT 100/VT 220</b> by default.
<b>Redirection After Boot</b>	Enables or disables the BIOS console redirection when the operating system is loaded. This option is set to <b>Enabled</b> by default.

## System Profile Settings

You can use the **System Profile Settings** screen to enable specific system performance settings such as power management.

## Viewing System Profile Settings

To view the **System Profile Settings** screen, perform the following steps:

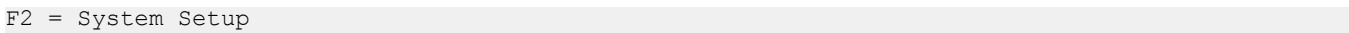
- 1 Turn on, or restart your system.
- 2 Press F2 immediately after you see the following message:  

- 3 On the **System Setup Main Menu** screen, click **System BIOS**.
- 4 On the **System BIOS** screen, click **System Profile Settings**.

**NOTE:** If your operating system begins to load before you press F2, wait for the system to finish booting, and then restart your system and try again.

## System Profile Settings details

The **System Profile Settings** screen details are explained as follows:

Option	Description
<b>System Profile</b>	<p>Sets the system profile. If you set the System Profile option to a mode other than <b>Custom</b>, the BIOS automatically sets the rest of the options. You can only change the rest of the options if the mode is set to <b>Custom</b>. This option is set to <b>Performance Per Watt Optimized (DAPC)</b> by default. DAPC is Dell Active Power Controller.</p> <p><b>NOTE:</b> All the parameters on the system profile setting screen are available only when the System Profile option is set to Custom.</p>
<b>CPU Power Management</b>	Sets the CPU power management. This option is set to <b>System DBPM (DAPC)</b> by default. DBPM is Demand-Based Power Management.
<b>Memory Frequency</b>	Sets the speed of the system memory. You can select <b>Maximum Performance</b> , <b>Maximum Reliability</b> , or a specific speed. This option is set to <b>Maximum Performance</b> by default.

Option	Description
<b>Turbo Boost</b>	Enables or disables the processor to operate in the turbo boost mode. This option is set to <b>Enabled</b> by default.
<b>C1E</b>	Enables or disables the processor to switch to a minimum performance state when it is idle. This option is set to <b>Enabled</b> by default.
<b>C States</b>	Enables or disables the processor to operate in all available power states. This option is set to <b>Enabled</b> by default.
<b>Write Data CRC</b>	Enables or disables the Write Data CRC. This option is set to <b>Enabled</b> by default.
<b>Memory Patrol Scrub</b>	Sets the memory patrol scrub frequency. This option is set to <b>Standard</b> by default.
<b>Memory Refresh Rate</b>	Sets the memory refresh rate to either 1x or 2x. This option is set to <b>1x</b> by default.
<b>Uncore Frequency</b>	Enables you to select the <b>Processor Uncore Frequency</b> option. Dynamic mode enables the processor to optimize power resources across the cores and uncore during runtime. The optimization of the uncore frequency to either save power or optimize performance is influenced by the setting of the <b>Energy Efficiency Policy</b> option.
<b>Energy Efficient Policy</b>	Enables you to select the <b>Energy Efficient Policy</b> option. The CPU uses the setting to manipulate the internal behavior of the processor and determines whether to target higher performance or better power savings.
<b>Number of Turbo Boot Enabled Cores for Processor 1</b>	<p><b>NOTE:</b> If there are two processors installed in the system, you will see an entry for <b>Number of Turbo Boost Enabled Cores for Processor 2</b>.</p> <p>Controls the number of turbo boost enabled cores for Processor 1. The maximum number of cores is enabled by default.</p>
<b>Monitor/Mwait</b>	<p>Enables the Monitor/Mwait instructions in the processor. This option is set to <b>Enabled</b> for all system profiles, except <b>Custom</b> by default.</p> <p><b>NOTE:</b> This option can be disabled only if the <b>C States</b> option in the <b>Custom mode</b> is set to <b>disabled</b>.</p> <p><b>NOTE:</b> When <b>C States</b> is set to <b>Enabled</b> in the <b>Custom mode</b>, changing the <b>Monitor/Mwait</b> setting does not impact the system power or performance.</p>
<b>CPU Interconnect Bus Link Power Management</b>	Enables or disables the CPU Interconnect Bus Link Power Management. This option is set to <b>Enabled</b> by default.
<b>PCI ASPM L1 Link Power Management</b>	Enables or disables the PCI ASPM L1 Link Power Management. This option is set to <b>Enabled</b> by default.

# System Security

You can use the **System Security** screen to perform specific functions such as setting the system password, setup password and disabling the power button.

## Viewing System Security

To view the **System Security** screen, perform the following steps:

- 1 Turn on, or restart your system.
- 2 Press F2 immediately after you see the following message:

F2 = System Setup

**NOTE:** If your operating system begins to load before you press F2, wait for the system to finish booting, and then restart your system and try again.

- 3 On the **System Setup Main Menu** screen, click **System BIOS**.
- 4 On the **System BIOS** screen, click **System Security**.

## System Security Settings details

The **System Security Settings** screen details are explained as follows:

Option	Description
<b>In-Band Manageability Interface</b>	<p>When set to <b>Disabled</b>, this setting will hide the Management Engine's (ME), HECI devices, and the system's IPMI devices from the operating system. This prevents the operating system from changing the ME power capping settings, and blocks access to all in-band management tools. All management should be managed through out-of-band. This option is set to <b>Enabled</b> by default.</p> <p><b>NOTE:</b> BIOS update requires HECI devices to be operational and DUP updates require IPMI interface to be operational. This setting needs to be set to <b>Enabled</b> to avoid updating errors.</p>
<b>Intel AES-NI</b>	<p>Improves the speed of applications by performing encryption and decryption by using the Advanced Encryption Standard Instruction Set (AES-NI). This option is set to <b>Enabled</b> by default.</p>
<b>System Password</b>	<p>Sets the system password. This option is set to <b>Enabled</b> by default and is read-only if the password jumper is not installed in the system.</p>
<b>Setup Password</b>	<p>Sets the setup password. This option is read-only if the password jumper is not installed in the system.</p>
<b>Password Status</b>	<p>Locks the system password. This option is set to <b>Unlocked</b> by default.</p>
<b>TPM Security</b>	<p><b>NOTE:</b> The TPM menu is available only when the TPM module is installed.</p> <p>Enables you to control the reporting mode of the TPM. The <b>TPM Security</b> option is set to <b>Off</b> by default. You can only modify the TPM Status, TPM Activation, and the Intel TXT fields if the <b>TPM Status</b> field is set to either <b>On with Pre-boot Measurements</b> or <b>On without Pre-boot Measurements</b>.</p> <p>When TPM 1.2 is installed, the <b>TPM Security</b> option is set to <b>Off</b>, <b>On with Pre-boot Measurements</b>, or <b>On without Pre-boot Measurements</b>.</p> <p>When TPM 2.0 is installed, the <b>TPM Security</b> option is set to <b>On</b> or <b>Off</b>. This option is set to <b>Off</b> by default.</p>
<b>TPM Information</b>	<p>Changes the operational state of the TPM. This option is set to <b>No Change</b> by default.</p>
<b>TPM Status</b>	<p>Specifies the TPM status.</p>



Option	Description
<b>TPM Command</b>	<p>Controls the Trusted Platform Module (TPM). When set to <b>None</b>, no command is sent to the TPM. When set to <b>Activate</b>, the TPM is enabled and activated. When set to <b>Deactivate</b>, the TPM is disabled and deactivated. When set to <b>Clear</b>, all the contents of the TPM are cleared. This option is set to <b>None</b> by default.</p> <p> <b>CAUTION: Clearing the TPM results in the loss of all keys in the TPM. The loss of TPM keys may affect booting to the operating system.</b></p> <p>This field is read-only when <b>TPM Security</b> is set to <b>Off</b>. The action requires an additional reboot before it can take effect.</p>
<b>Intel(R) TXT</b>	<p>Enables or disables the Intel Trusted Execution Technology (TXT) option. To enable the <b>Intel TXT</b> option, virtualization technology and TPM Security must be enabled with Pre-boot measurements. This option is set to <b>Off</b> by default.</p> <p>When TPM 2.0 is installed, <b>TPM 2 Algorithm</b> option is available. It enables you to select a hash algorithm from those supported by the TPM (SHA1, SHA256). <b>TPM 2 Algorithm</b> option must be set to <b>SHA256</b>, to enable TXT.</p>
<b>Power Button</b>	Enables or disables the power button on the front of the system. This option is set to <b>Enabled</b> by default.
<b>AC Power Recovery</b>	Sets how the system behaves after AC power is restored to the system. This option is set to <b>Last</b> by default.
<b>AC Power Recovery Delay</b>	Sets the time delay for the system to power up after AC power is restored to the system. This option is set to <b>Immediate</b> by default.
<b>User Defined Delay (60 s to 240 s)</b>	Sets the <b>User Defined Delay</b> option when the <b>User Defined</b> option for <b>AC Power Recovery Delay</b> is selected.
<b>UEFI Variable Access</b>	Provides varying degrees of securing UEFI variables. When set to <b>Standard</b> (the default), UEFI variables are accessible in the operating system per the UEFI specification. When set to <b>Controlled</b> , selected UEFI variables are protected in the environment and new UEFI boot entries are forced to be at the end of the current boot order.
<b>Secure Boot</b>	Enables Secure Boot, where the BIOS authenticates each pre-boot image by using the certificates in the Secure Boot Policy. Secure Boot is set to <b>Disabled</b> by default.
<b>Secure Boot Policy</b>	When Secure Boot policy is set to <b>Standard</b> , the BIOS uses the system manufacturer's key and certificates to authenticate pre-boot images. When Secure Boot policy is set to <b>Custom</b> , the BIOS uses the user-defined key and certificates. Secure Boot policy is set to <b>Standard</b> by default.
<b>Secure Boot Mode</b>	Configures how the BIOS uses the Secure Boot Policy Objects (PK, KEK, db, dbx). If the current mode is set to <b>Deployed Mode</b> , the available options are <b>User Mode</b> and <b>Deployed Mode</b> . If the current mode is set to <b>User Mode</b> , the available options are <b>User Mode</b> , <b>Audit Mode</b> , and <b>Deployed Mode</b> .

Options	Description
<b>User Mode</b>	<p>In <b>User Mode</b>, PK must be installed, and BIOS performs signature verification on programmatic attempts to update policy objects.</p> <p>The BIOS allows unauthenticated programmatic transitions between modes.</p>
<b>Audit Mode</b>	<p>In <b>Audit mode</b>, PK is not present. The BIOS does not authenticate programmatic updates to the policy objects, and transitions between modes.</p> <p><b>Audit Mode</b> is useful for programmatically determining a working set of policy objects.</p> <p>BIOS performs signature verification on pre-boot images and logs results in the image Execution Information Table, but executes the images whether they pass or fail verification.</p>

Option	Description				
	<table border="1"> <thead> <tr> <th>Options</th> <th>Description</th> </tr> </thead> <tbody> <tr> <td><b>Deployed Mode</b></td> <td> <p><b>Deployed Mode</b> is the most secure mode. In <b>Deployed Mode</b>, PK must be installed and the BIOS performs signature verification on programmatic attempts to update policy objects.</p> <p><b>Deployed Mode</b> restricts the programmatic mode transitions.</p> </td> </tr> </tbody> </table>	Options	Description	<b>Deployed Mode</b>	<p><b>Deployed Mode</b> is the most secure mode. In <b>Deployed Mode</b>, PK must be installed and the BIOS performs signature verification on programmatic attempts to update policy objects.</p> <p><b>Deployed Mode</b> restricts the programmatic mode transitions.</p>
Options	Description				
<b>Deployed Mode</b>	<p><b>Deployed Mode</b> is the most secure mode. In <b>Deployed Mode</b>, PK must be installed and the BIOS performs signature verification on programmatic attempts to update policy objects.</p> <p><b>Deployed Mode</b> restricts the programmatic mode transitions.</p>				
<b>Secure Boot Policy Summary</b>	Specifies the list of certificates and hashes that secure boot uses to authenticate images.				
<b>Secure Boot Custom Policy Settings</b>	Configures the Secure Boot Custom Policy. To enable this option, set the Secure Boot Policy to <b>Custom</b> option.				

## Creating a system and setup password

### Prerequisite

Ensure that the password jumper is enabled. The password jumper enables or disables the system password and setup password features. For more information, see the System board jumper settings section.

**NOTE:** If the password jumper setting is disabled, the existing system password and setup password are deleted and you need not provide the system password to boot the system.

### Steps

- To enter System Setup, press F2 immediately after turning on or rebooting your system.
- On the **System Setup Main Menu** screen, click **System BIOS > System Security**.
- On the **System Security** screen, verify that **Password Status** is set to **Unlocked**.
- In the **System Password** field, type your system password, and press Enter or Tab.  
A message prompts you to reenter the system password.
- Reenter the system password, and click **OK**.
- In the **Setup Password** field, type your setup password and press Enter or Tab.  
A message prompts you to reenter the setup password.
- Reenter the setup password, and click **OK**.
- Press Esc to return to the System BIOS screen. Press Esc again.  
A message prompts you to save the changes.

**NOTE:** Password protection does not take effect until the system reboots.

### Related link

[System board jumper settings](#)

## Using your system password to secure your system

### About this task

If you have assigned a setup password, the system accepts your setup password as an alternate system password.

### Steps

- Turn on or reboot your system.
- Type the system password and press Enter.

### Next step

When **Password Status** is set to **Locked**, type the system password and press Enter when prompted at reboot.

**NOTE:** If an incorrect system password is typed, the system displays a message and prompts you to reenter your password. You have three attempts to type the correct password. After the third unsuccessful attempt, the system displays an error message that the system has stopped functioning and must be turned off. Even after you turn off and restart the system, the error message is displayed until the correct password is entered.

## Deleting or changing system and setup password

### Prerequisite

**NOTE:** You cannot delete or change an existing system or setup password if the **Password Status** is set to **Locked**.

### Steps

- 1 To enter System Setup, press F2 immediately after turning on or restarting your system.
- 2 On the **System Setup Main Menu** screen, click **System BIOS > System Security**.
- 3 On the **System Security** screen, ensure that **Password Status** is set to **Unlocked**.
- 4 In the **System Password** field, alter or delete the existing system password, and then press Enter or Tab.
- 5 In the **Setup Password** field, alter or delete the existing setup password, and then press Enter or Tab.  
If you change the system and setup password, a message prompts you to reenter the new password. If you delete the system and setup password, a message prompts you to confirm the deletion.
- 6 Press Esc to return to the **System BIOS** screen. Press Esc again, and a message prompts you to save the changes.

## Operating with setup password enabled

If **Setup Password** is set to **Enabled**, type the correct setup password before modifying the system setup options.

If you do not type the correct password in three attempts, the system displays the following message:

```
Invalid Password! Number of unsuccessful password attempts: <x> System Halted! Must power down.
```

Even after you turn off and restart the system, the error message is displayed until the correct password is typed. The following options are exceptions:

- If **System Password** is not set to **Enabled** and is not locked through the **Password Status** option, you can assign a system password. For more information, see the System Security Settings screen section.
- You cannot disable or change an existing system password.

**NOTE:** You can use the password status option with the setup password option to protect the system password from unauthorized changes.

### Related link

[System Security Settings details](#)

## Redundant OS Control

You can use the **Redundant OS Control** screen to set the redundant OS info for redundant OS control. It enables you to set up a physical recovery disk on your system.

## Viewing Redundant OS Control

To view the **Redundant OS Control** screen, perform the following steps:

- 1 Turn on, or restart your system.
- 2 Press F2 immediately after you see the following message:

F2 = System Setup

**NOTE:** If your operating system begins to load before you press F2, wait for the system to finish booting, and then restart your system and try again.

- 3 On the **System Setup Main Menu** screen, click **System BIOS**.
- 4 On the **System BIOS** screen, click **Redundant OS Control**.

## Redundant OS Control screen details

The **Redundant OS Control** screen details are explained as follows:

Option	Description
<b>Redundant OS Location</b>	<p>Enables you to select a backup disk from the following devices:</p> <ul style="list-style-type: none"><li>• <b>None</b></li><li>• <b>IDSDM</b></li><li>• <b>SATA Ports in AHCI mode</b></li><li>• <b>BOSS PCIe Cards (Internal M.2 Drives)</b></li><li>• <b>Internal USB</b></li></ul> <p><b>NOTE:</b> RAID configurations and NVMe cards not are included as BIOS does not have the ability to distinguish between individual drives in those configurations.</p>
<b>Redundant OS State</b>	<p><b>NOTE:</b> This option is disabled if <b>Redundant OS Location</b> is set to <b>None</b>.</p> <p>When set to <b>Visible</b>, the backup disk is visible to the boot list and OS. When set to <b>Hidden</b>, the backup disk is disabled and is not visible to the boot list and OS. This option is set to <b>Visible</b> by default.</p> <p><b>NOTE:</b> BIOS will disable the device in hardware, so it cannot be accessed by the OS.</p>
<b>Redundant OS Boot</b>	<p><b>NOTE:</b> This option is disabled if <b>Redundant OS Location</b> is set to <b>None</b> or if <b>Redundant OS State</b> is set to <b>Hidden</b>.</p> <p>When set to <b>Enabled</b>, BIOS boots to the device specified in <b>Redundant OS Location</b>. When set to <b>Disabled</b>, BIOS preserves the current boot list settings. This option is set to <b>Enabled</b> by default.</p>

# Miscellaneous Settings

You can use the **Miscellaneous Settings** screen to perform specific functions such as updating the asset tag and changing the system date and time.

## Viewing Miscellaneous Settings

To view the **Miscellaneous Settings** screen, perform the following steps:

- 1 Turn on, or restart your system.
- 2 Press F2 immediately after you see the following message:

F2 = System Setup

**NOTE:** If your operating system begins to load before you press F2, wait for the system to finish booting, and then restart your system and try again.

- 3 On the **System Setup Main Menu** screen, click **System BIOS**.
- 4 On the **System BIOS** screen, click **Miscellaneous Settings**.

## Miscellaneous Settings details

The **Miscellaneous Settings** screen details are explained as follows:

Option	Description
<b>System Time</b>	Enables you to set the time on the system.
<b>System Date</b>	Enables you to set the date on the system.
<b>Asset Tag</b>	Specifies the asset tag and enables you to modify it for security and tracking purposes.
<b>Keyboard NumLock</b>	Enables you to set whether the system boots with the NumLock enabled or disabled. This option is set to <b>On</b> by default. <b>NOTE:</b> This option does not apply to 84-key keyboards.
<b>F1/F2 Prompt on Error</b>	Enables or disables the F1/F2 prompt on error. This option is set to <b>Enabled</b> by default. The F1/F2 prompt also includes keyboard errors.
<b>Load Legacy Video Option ROM</b>	Enables you to determine whether the system BIOS loads the legacy video (INT 10H) option ROM from the video controller. Selecting <b>Enabled</b> in the operating system does not support UEFI video output standards. This field is available only for UEFI boot mode. You cannot set the option to <b>Enabled</b> if <b>UEFI Secure Boot</b> mode is enabled.
<b>Dell Wyse P25/P45 BIOS Access</b>	Enables or disables the Dell Wyse P25/P45 BIOS Access. This option is set to <b>Enabled</b> by default.
<b>Power Cycle Request</b>	Enables or disables the Power Cycle Request. This option is set to <b>None</b> by default.

## iDRAC Settings utility

The iDRAC settings utility is an interface to set up and configure the iDRAC parameters by using UEFI. You can enable or disable various iDRAC parameters by using the iDRAC settings utility.

**NOTE:** Accessing some of the features on the iDRAC settings utility needs the iDRAC Enterprise License upgrade.

For more information about using iDRAC, see *Dell Integrated Dell Remote Access Controller User's Guide* at [Dell.com/idracmanuals](http://Dell.com/idracmanuals).

#### Related link

[Device Settings](#)  
[System BIOS](#)

## Device Settings

**Device Settings** enables you to configure device parameters.

#### Related link

[System BIOS](#)

## Dell Lifecycle Controller

Dell Lifecycle Controller (LC) provides advanced embedded systems management capabilities including system deployment, configuration, update, maintenance, and diagnosis. LC is delivered as part of the iDRAC out-of-band solution and Dell system embedded Unified Extensible Firmware Interface (UEFI) applications.

#### Related link

[Embedded system management](#)

## Embedded system management

The Dell Lifecycle Controller provides advanced embedded system management throughout the system's lifecycle. The Dell Lifecycle Controller can be started during the boot sequence and can function independently of the operating system.

**NOTE:** Certain platform configurations may not support the full set of features provided by the Dell Lifecycle Controller.

For more information about setting up the Dell Lifecycle Controller, configuring hardware and firmware, and deploying the operating system, see the Dell Lifecycle Controller documentation at [Dell.com/idracmanuals](http://Dell.com/idracmanuals).

#### Related link

[Dell Lifecycle Controller](#)

## Boot Manager

The **Boot Manager** screen enables you to select boot options and diagnostic utilities.

#### Related link

[Boot Manager main menu](#)  
[System BIOS](#)  
[Viewing Boot Manager](#)

## Viewing Boot Manager

#### About this task

To enter Boot Manager:

#### Steps

- 1 Turn on, or restart your system.  
Enter the result of your step here (optional).
- 2 Press F11 when you see the following message:  
F11 = Boot Manager

If your operating system begins to load before you press F11, allow the system to complete the booting, and then restart your system and try again.

**Related link**

[Boot Manager](#)

[Boot Manager main menu](#)

## Boot Manager main menu

Menu item	Description
<b>Continue Normal Boot</b>	The system attempts to boot to devices starting with the first item in the boot order. If the boot attempt fails, the system continues with the next item in the boot order until the boot is successful or no more boot options are found.
<b>One-shot Boot Menu</b>	Enables you to access boot menu, where you can select a one-time boot device to boot from.
<b>Launch System Setup</b>	Enables you to access System Setup.
<b>Launch Lifecycle Controller</b>	Exits the Boot Manager and invokes the Dell Lifecycle Controller program.
<b>System Utilities</b>	Enables you to launch System Utilities menu such as System Diagnostics and UEFI shell.

**Related link**

[Boot Manager](#)

[Viewing Boot Manager](#)

## One-shot BIOS boot menu

**One-shot BIOS boot menu** enables you to select a boot device to boot from.

**Related link**

[Boot Manager](#)

## System Utilities

**System Utilities** contains the following utilities that can be launched:

- Launch Diagnostics
- BIOS Update File Explorer
- Reboot System

**Related link**

[Boot Manager](#)

## PXE boot

You can use the Preboot Execution Environment (PXE) option to boot and configure the networked systems, remotely.

To access the **PXE boot** option, boot the system and then press F12 during POST instead of using standard Boot Sequence from BIOS Setup. It does not pull any menu or allows managing of network devices.

# Installing and removing system components

## Safety instructions

- ⚠ WARNING:** Whenever you need to lift the system, get others to assist you. To avoid injury, do not attempt to lift the system by yourself.
- ⚠ WARNING:** Opening or removing the system cover while the system is powered on may expose you to a risk of electric shock.
- ⚠ CAUTION:** Do not operate the system without the cover for a duration exceeding five minutes. Operating the system without the system cover can result in component damage.
- ⚠ CAUTION:** Many repairs may only be done by a certified service technician. You should only perform troubleshooting and simple repairs as authorized in your product documentation, or as directed by the online or telephone service and support team. Damage due to servicing that is not authorized by Dell is not covered by your warranty. Read and follow the safety instructions that are shipped with your product.
- 📌 NOTE:** It is recommended that you always use an antistatic mat and antistatic strap while working on components inside the system.
- ⚠ CAUTION:** To ensure proper operation and cooling, all bays in the system and system fans must be always populated with a component or a blank.

## Before working inside your system

### Prerequisite

Follow the safety guidelines listed in [Safety instructions](#).

### Steps

- 1 Turn off the system, including any attached peripherals.
- 2 Disconnect the system from the electrical outlet and disconnect the peripherals.
- 3 If applicable, remove the system from the rack.  
For more information, see the *Rack Installation Guide* at [Dell.com/poweredgemanuals](https://Dell.com/poweredgemanuals).
- 4 Remove the system cover.

### Related link

[Removing the system cover](#)

## After working inside your system

### Prerequisite

Follow the safety guidelines listed in [Safety instructions](#).

### Steps

- 1 Install the system cover.
- 2 If applicable, install the system into the rack.  
For more information, see the *Rack Installation Guide* at [Dell.com/poweredgemanuals](https://Dell.com/poweredgemanuals).
- 3 Reconnect the peripherals and connect the system to the electrical outlet.
- 4 Turn on the system, including any attached peripherals.



### Related link

[Installing the system cover](#)

## Recommended tools

You need the following tools to perform the removal and installation procedures:

- Key to the bezel lock  
The key is required only if your system includes a bezel.
- Phillips #1 screwdriver
- Phillips #2 screwdriver
- Torx #T30 screwdriver
- Torx #T8 screwdriver
- Wrist grounding strap

You need the following tools to assemble the cables for a DC power supply unit:

- AMP 90871-1 hand-crimping tool or equivalent
- Tyco Electronics 58433-3 or equivalent
- Wire-stripper pliers to remove insulation from size 10 AWG solid or stranded, insulated copper wire

 **NOTE: Use alpha wire part number 3080 or equivalent (65/30 stranding).**

## Optional front bezel

An optional metal bezel is mounted on the front of the system to display system branding. A lock on the bezel is used to protect unauthorized access to the drives. There are two versions of bezel available:

- With LCD panel
- Without LCD panel

For bezels with LCD panel, the system status can be viewed on the LCD panel. For more information, see the LCD panel section.

The LCD bezel is hot pluggable and can be used in any server of the same branding even if that system was originally not ordered with that LCD bezel.

### Related link

[LCD panel](#)

## Removing the optional front bezel

The procedure to remove the optional front bezel with the LCD panel and the front bezel without the LCD panel is the same.

### Prerequisite

Follow the safety guidelines listed in [Safety instructions](#).

### Steps

1. Unlock the bezel by using the bezel key.
2. Press the release button, and pull the left end of the bezel.
3. Unhook the right end, and remove the bezel.

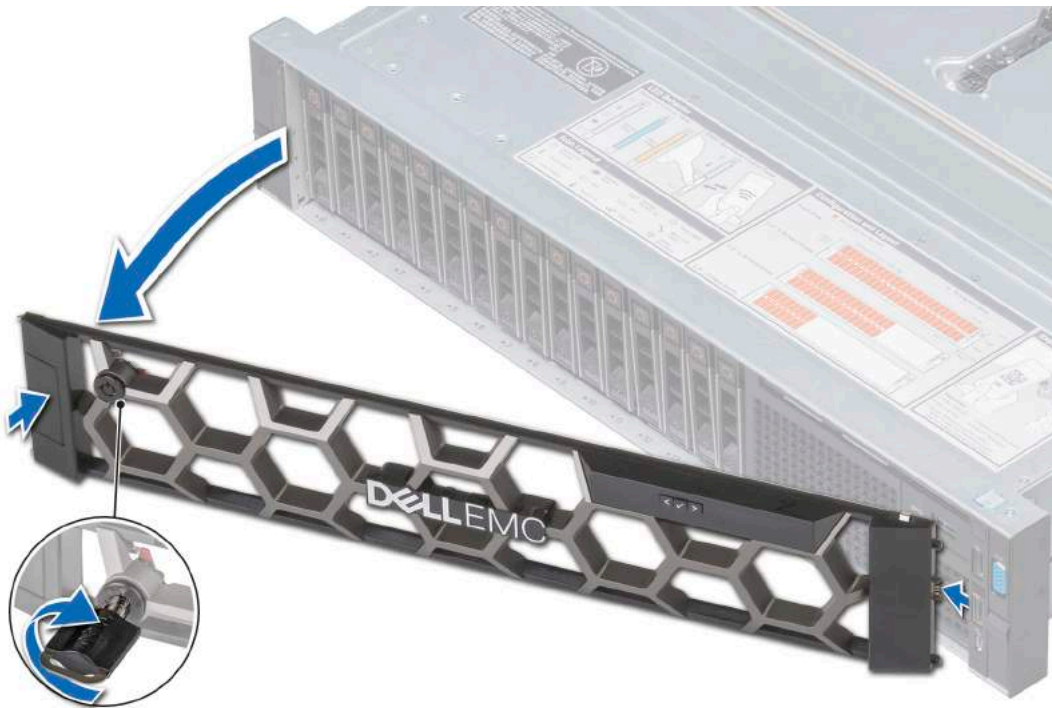

Figure 17. Removing the optional front bezel with the LCD panel

## Installing the optional front bezel

The procedure to install the optional front bezel with the LCD panel and the front bezel without the LCD panel is the same.

### Prerequisite

Follow the safety guidelines listed in [Safety instructions](#).

### Steps

- 1 Locate and remove the bezel key.
  - ① **NOTE: The bezel key is part of the LCD bezel package.**
- 2 Align and insert the right end of the bezel onto the system.
- 3 Press the release button and fit the left end of the bezel onto the system.
- 4 Lock the bezel by using the key.



Figure 18. Installing the optional front bezel with the LCD panel

## System cover

System cover provides security for the entire system and also helps in maintaining proper air flow inside the system.

## Removing the system cover

### Prerequisites

- 1 Follow the safety guidelines listed in [Safety instructions](#).
- 2 Turn off the system, including any attached peripherals.
- 3 Disconnect the system from the electrical outlet and disconnect the peripherals.

### Steps

- 1 Using a flat or a Phillips head screwdriver, rotate the latch release lock counter clockwise to the unlocked position.
- 2 Lift the latch till the system cover slides back and the tabs on the system cover disengage from the guide slots on the system.
- 3 Hold the cover on both sides, and lift the cover away from the system.



Figure 19. Removing the system cover

## Installing the system cover

### Prerequisites

- 1 Follow the safety guidelines listed in [Safety instructions](#).
- 2 Ensure that all internal cables are routed correctly and connected, and no tools or extra parts are left inside the system.

### Steps

- 1 Align the tabs on the system cover with the guide slots on the system.
- 2 Push the system cover latch down.  
The system cover slides forward, the tabs on the system cover engage with the guide slots on the system and the system cover latch locks into place.
- 3 Using a flat or Phillips head screwdriver, rotate the latch release lock clockwise to the locked position.



Figure 20. Installing system cover

#### Next steps

- 1 Reconnect the peripherals and connect the system to the electrical outlet.
- 2 Turn on the system, including any attached peripherals.

## Backplane cover

### Removing the backplane cover

#### Prerequisites

- 1 Follow the safety guidelines listed in [Safety instructions](#).
- 2 Follow the procedure listed in [Before working inside your system](#).

#### Steps

- 1 Slide the backplane cover in the direction of the arrows marked on the backplane cover.
- 2 Lift the backplane cover away from the system.

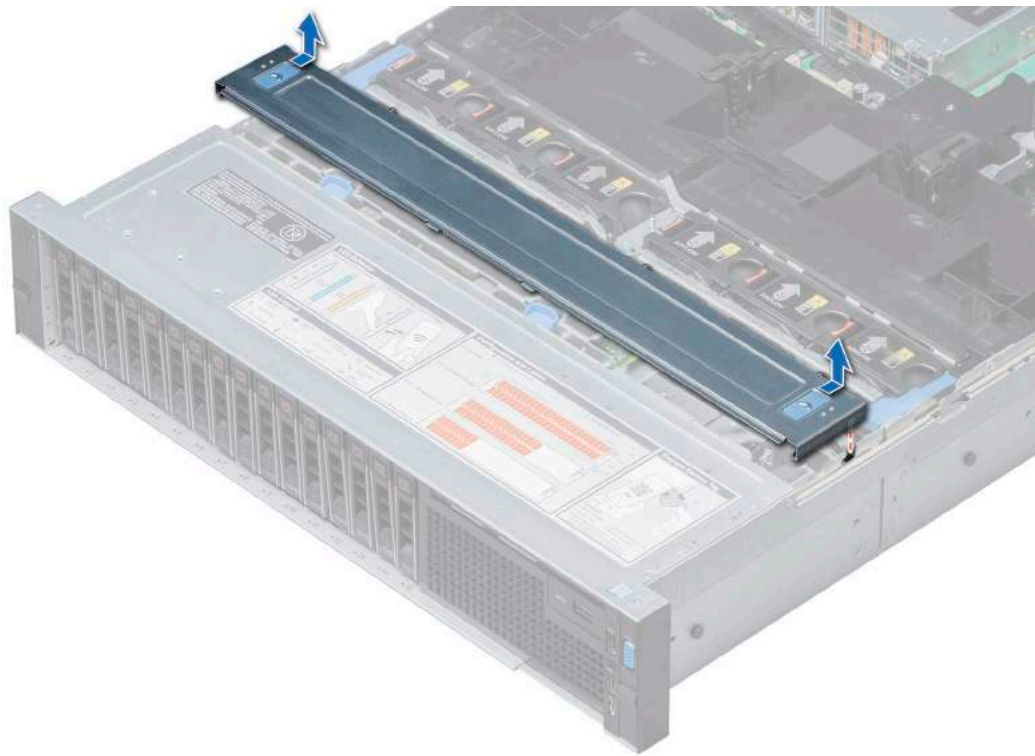

Figure 21. Removing backplane cover

## Installing the backplane cover

### Prerequisite

Follow the safety guidelines listed in [Safety instructions](#).

### Steps

- 1 Align the backplane cover with the guide slots on the system.
- 2 Slide the backplane cover toward the front of the system until the cover locks into place.



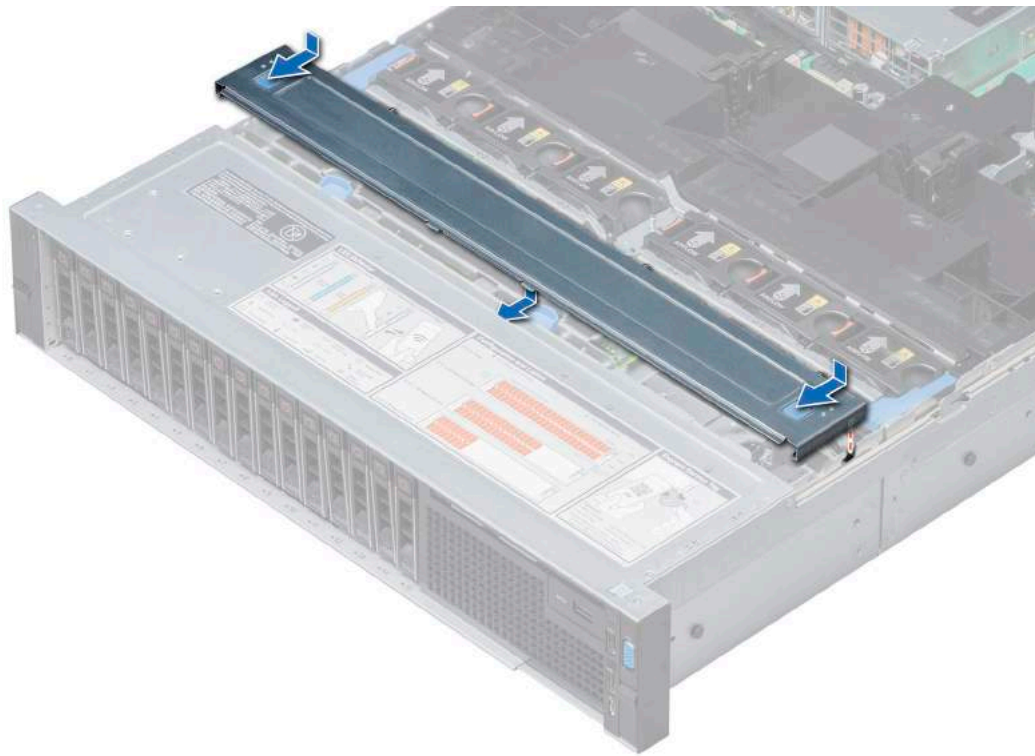

Figure 22. Installing the backplane cover

#### Next step

Follow the procedure listed in [After working inside your system.](#)

## Inside the system

**CAUTION:** Many repairs may only be done by a certified service technician. You should only perform troubleshooting and simple repairs as authorized in your product documentation, or as directed by the online or telephone service and support team. Damage due to servicing that is not authorized by Dell is not covered by your warranty. Read and follow the safety instructions that are shipped with your product.

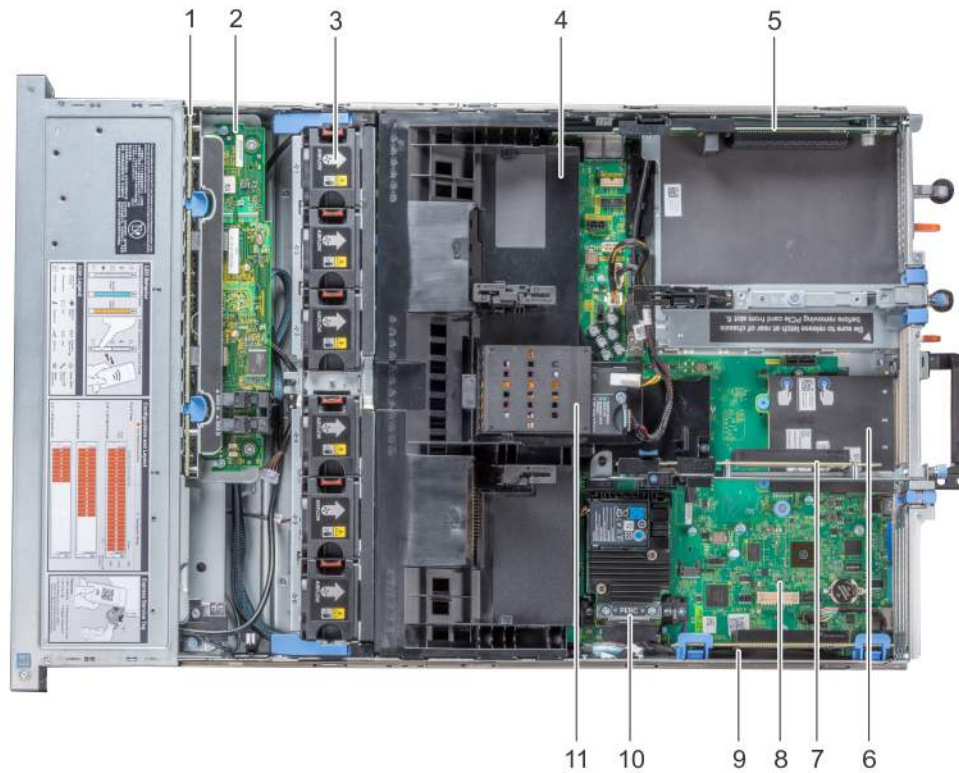

**Figure 23. Inside the system – NVDIMM-N battery**

- |    |   |    |                                    |
|----|---|----|------------------------------------|
| 1  | drive backplane                             | 2  | backplane expander card            |
| 3  | cooling fan (6) in the cooling fan assembly | 4  | air shroud                         |
| 5  | expansion card riser 3                      | 6  | network daughter card              |
| 7  | expansion card riser 2                      | 8  | system board                       |
| 9  | expansion card riser 1                      | 10 | integrated storage controller card |
| 11 | NVDIMM-N battery                            |    |                                    |



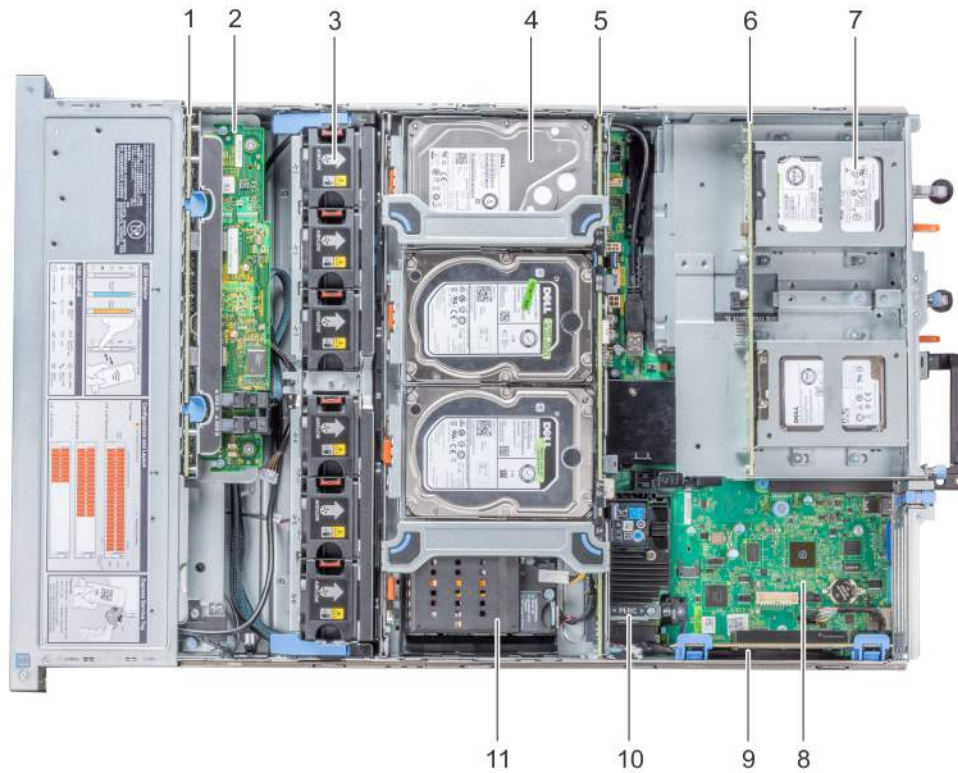

**Figure 24. Inside the system – mid drive tray and rear drive cage**

- |    |   |    |                                    |
|----|---|----|------------------------------------|
| 1  | drive backplane                             | 2  | backplane expander card            |
| 3  | cooling fan (6) in the cooling fan assembly | 4  | drive (4) in the mid drive tray    |
| 5  | mid drive backplane                         | 6  | rear drive backplane               |
| 7  | drive (2 or 4) in the rear drive cage       | 8  | system board                       |
| 9  | expansion card riser 1                      | 10 | integrated storage controller card |
| 11 | NVDIMM-N battery                            |    |                                    |

## Air shroud

The air shroud directs the airflow across the entire system. Air shroud prevents the system from overheating and is used to maintain uniform airflow inside the system.

# Removing the air shroud

## Prerequisites

**CAUTION:** Never operate your system with the air shroud removed. The system may get overheated quickly, resulting in shutdown of the system and loss of data.

- 1 Follow the safety guidelines listed in [Safety instructions](#).
- 2 Follow the procedure listed in [Before working inside your system](#).
- 3 If installed, remove the full length PCIe cards.
- 4 If applicable, remove the GPU cards.
- 5 If NVDIMM-N battery is installed, disconnect the cables from the NVDIMM-N battery.

**CAUTION:** NVDIMM-N battery is not hot swappable. To prevent data loss and potential damage to your system, ensure that your system, LEDs on system, LEDs on NVDIMM-N and LEDs on NVDIMM-N battery are turned off before disconnecting the NVDIMM-N battery cables.

## Step

Hold the air shroud at both ends and lift it away from the system.

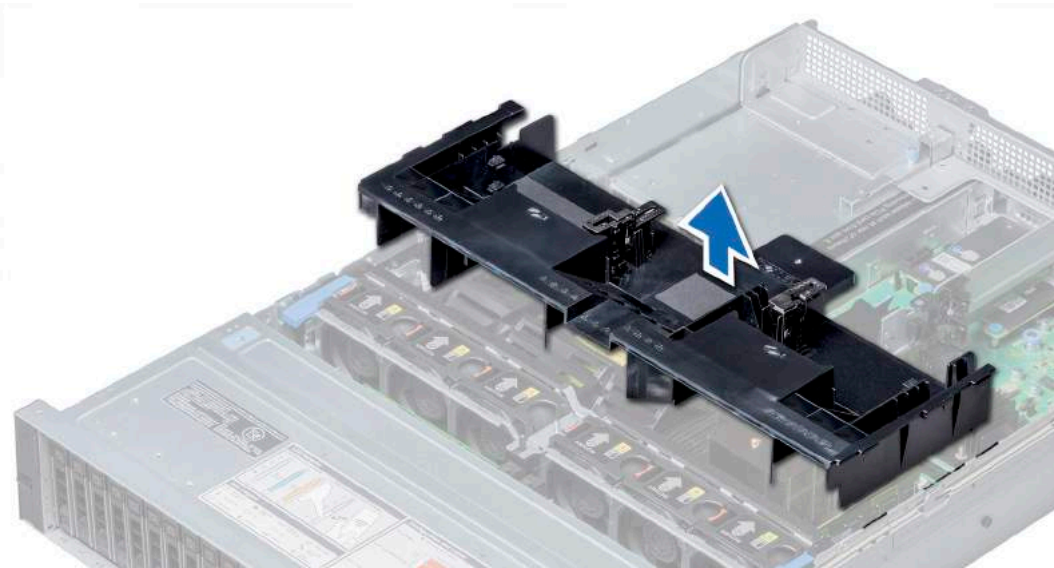

Figure 25. Removing air shroud

## Next step

If applicable, install the air shroud.

## Related link

[Removing the expansion card from expansion card riser](#)

[Installing the air shroud](#)

# Installing the air shroud

## Prerequisites

- 1 Follow the safety guidelines listed in [Safety instructions](#).
- 2 If applicable, route the cables inside the system along the system wall and secure the cables by using the cable latch.

## Steps

- 1 Align the tabs on the air shroud with the slots on the system.
- 2 Lower the air shroud into the system until it is firmly seated.

When firmly seated, the memory socket numbers marked on the air shroud align with the respective memory sockets.

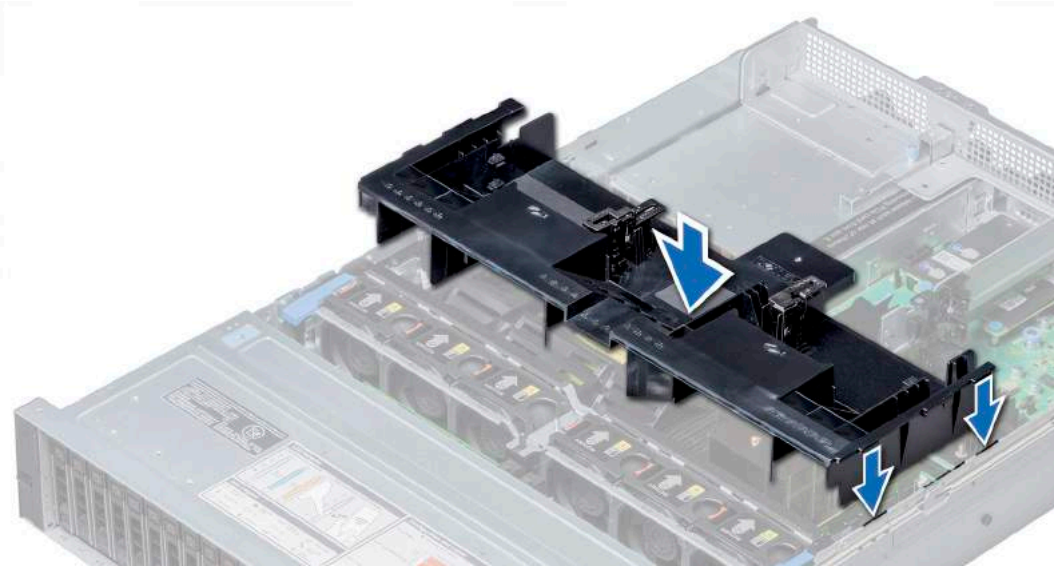

Figure 26. Installing air shroud

## Next steps

- 1 If removed, install the full length PCIe cards.
- 2 If applicable, install the GPU cards.
- 3 If applicable, connect the cables to the NVDIMM-N battery.

**CAUTION:** NVDIMM-N battery is not hot swappable. To prevent data loss and potential damage to your system, ensure that your system, LEDs on system, LEDs on NVDIMM-N and LEDs on NVDIMM-N battery are turned off before connecting the NVDIMM-N battery cables.

- 4 Follow the procedure listed in [After working inside your system](#).

## Related link

[Installing expansion card into expansion card riser](#)

# Cooling fan assembly

The cooling fan assembly ensures that the key components of the server such as the processors, drives, and memory get adequate air circulation to keep them cool. A failure in the server's cooling system can result in the server overheating and may lead to damage.

## Removing the cooling fan assembly

### Prerequisites

- 1 Follow the safety guidelines listed in [Safety instructions](#).
- 2 Follow the procedure listed in [Before working inside your system](#).

### Steps

- 1 Lift the release levers to unlock the cooling fan assembly from the system.
- 2 Hold the release levers, and lift the cooling fan assembly away from the system.



Figure 27. Removing the cooling fan assembly

### Next step

Install the cooling fan assembly.

### Related link

[Installing the cooling fan assembly](#)

## Installing the cooling fan assembly

### Prerequisite

Follow the safety guidelines listed in [Safety instructions](#).

**⚠ CAUTION:** Ensure that the cables inside the system are correctly installed and retained by the cable retention bracket before installing the cooling fan assembly. Incorrectly installed cables may get damaged.

### Steps

- 1 Align the guide rails on the cooling fan assembly with the standoffs on the system.
- 2 Lower the cooling fan assembly into the system until the cooling fan connectors engage with the connectors on the system board.
- 3 Press the release levers to lock the cooling fan assembly into the system.





**Figure 28. Installing the cooling fan assembly**

**Next step**

Follow the procedure listed in [After working inside your system.](#)

## Cooling fans

The cooling fans are integrated into the system to dissipate the heat generated by the functioning of the system. These fans provide cooling for the processors, expansion cards, and memory modules.

Your system supports up to six standard or high performance hot swappable cooling fans.

For single processor systems without a mid drive tray, only four cooling fans are required. Fan bays 1 and 2 are covered by a fan blank.

**⚠ CAUTION: Mixing of standard and high performance cooling fans is not supported.**

**📌 NOTE: Each fan is listed in the systems management software, referenced by the respective fan number. If there is a problem with a particular fan, you can easily identify and replace the proper fan by noting the fan numbers on the cooling fan assembly.**

**Table 37. Fan support matrix for R740xd**

Front Storage	PSU type	CPU count	Fan1	Fan2	Fan3	Fan4	Fan5	Fan6
8 x 3.5 inch	Cable PSU or Redundant PSU	1	Not required	Required	Required	Required	Required	Not required
	Redundant PSU	2	Not required	Required	Required	Required	Required	Required

Front Storage	PSU type	CPU count	Fan1	Fan2	Fan3	Fan4	Fan5	Fan6
12 x 3.5 inch	Redundant	1	Required	Required	Required	Required	Required	Not required
	PSU only	2	Required	Required	Required	Required	Required	Required

**NOTE:** The high performance fans are required for 12 x 3.5 inch drive + 2 x 3.5 inch rear drive system. For more information, see the Thermal restriction matrix topic in the Technical specifications section.

## Removing a cooling fan

The procedure for removing standard and high performance fans is identical.

### Prerequisites

**WARNING:** Opening or removing the system cover when the system is on may expose you to a risk of electric shock. Exercise utmost care while removing or installing cooling fans.

**CAUTION:** The cooling fans are hot swappable. To maintain proper cooling while the system is on, replace only one fan at a time.

- 1 Follow the safety guidelines listed in [Safety instructions](#).
- 2 Remove the air shroud.

### Step

Press the release tab and lift the cooling fan out of the cooling fan assembly.

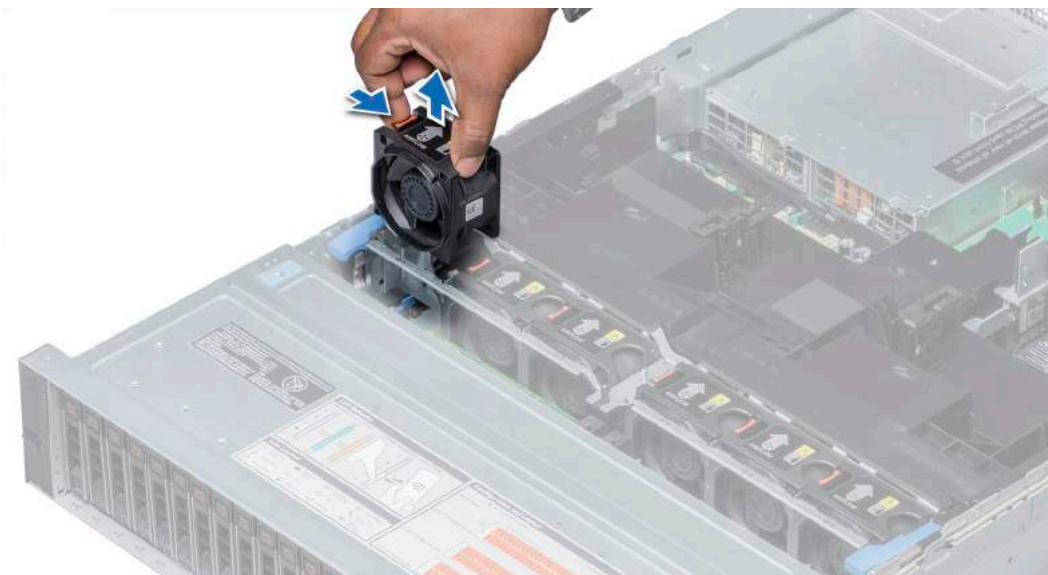

**Figure 29. Removing cooling fan**

### Next step

If applicable, install the cooling fan.

### Related link

[Removing the air shroud](#)

[Installing a cooling fan](#)

# Installing a cooling fan

The procedure for installing standard and high performance fans is identical.

## Prerequisites

- ⚠ WARNING:** Opening or removing the system cover when the system is on may expose you to a risk of electric shock. Exercise utmost care while removing or installing cooling fans.
- ⚠ CAUTION:** The cooling fans are hot swappable. To maintain proper cooling while the system is on, replace only one fan at a time.

Follow the safety guidelines listed in [Safety instructions](#).

## Steps

- 1 Holding the release tab, align the connector at the base of the cooling fan with the connector on the system board.

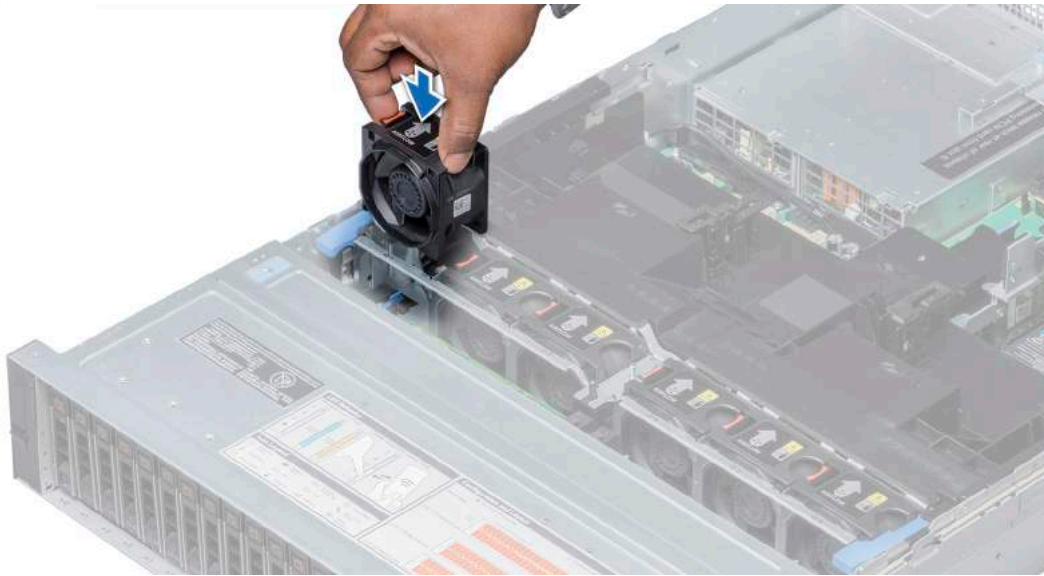

Figure 30. Installing cooling fan

- 2 Slide the cooling fan into the cooling fan assembly until the release tab locks into place.

## Next step

Install the air shroud.

## Related link

[Installing the air shroud](#)

# Intrusion switch

The chassis intrusion detection switch detects any intrusion into the system and creates a log entry in the system event log (SEL). This switch is activated when the cover of your system is removed.

# Removing an intrusion switch

## Prerequisites

- 1 Follow the safety guidelines listed in [Safety instructions](#).
- 2 Follow the procedure listed in [Before working inside your system](#).
- 3 Remove the cooling fan assembly.

## Step

Press the intrusion switch and slide it out of the intrusion switch slot.

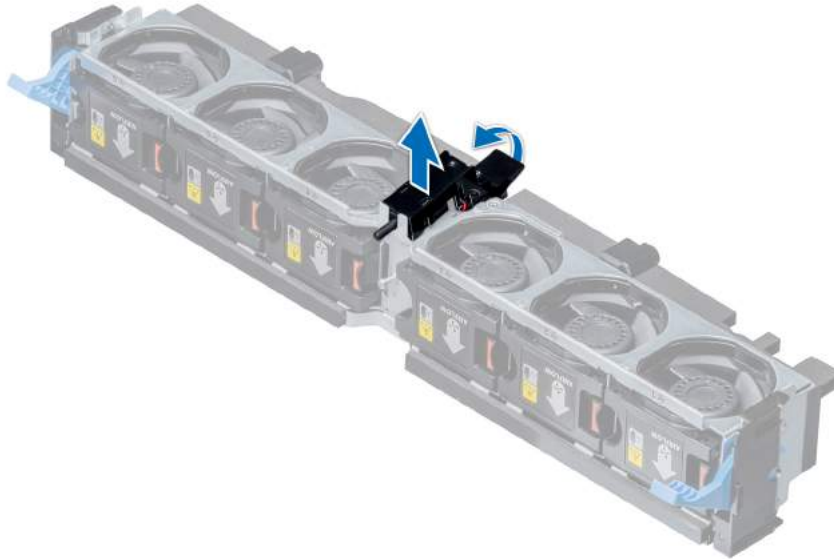

**Figure 31. Removing an intrusion switch**

## Next step

Install an intrusion switch.

## Related link

[Removing the cooling fan assembly](#)

[Installing an intrusion switch](#)

# Installing an intrusion switch

## Prerequisite

Follow the safety guidelines listed in [Safety instructions](#).

## Steps

- 1 Align the tabs on the intrusion switch with the slots on the cooling fan assembly.
- 2 Push the intrusion switch until it locks in place.



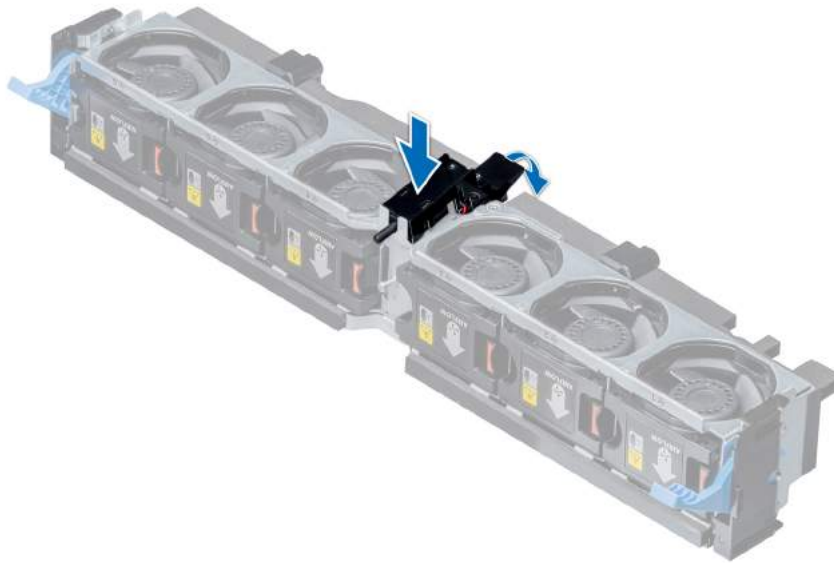

**Figure 32. Installing an intrusion switch**

#### Next steps

- 1 Install the cooling fan assembly.
- 2 Follow the procedure listed in [After working inside your system](#).

#### Related link

[Installing the cooling fan assembly](#)

## NVDIMM-N battery

NVDIMM-N battery can be installed on regular air shroud and 3.5 inch mid drive tray. NVDIMM-N battery is not supported on 2.5 inch NVMe mid tray.

## Removing the NVDIMM-N battery from the air shroud

#### Prerequisites

- 1 Follow the safety guidelines listed in [Safety instructions](#).
- 2 Follow the procedure listed in [Before working inside your system](#).

**CAUTION:** NVDIMM-N battery is not hot swappable. To prevent data loss and potential damage to your system, ensure that your system, LEDs on system, LEDs on NVDIMM-N and LEDs on NVDIMM-N battery are turned off before removing the NVDIMM-N battery.

**CAUTION:** To avoid damage to the battery connector, you must firmly support the connector while installing or removing a battery.

#### Steps

- 1 Disconnect the cables from the NVDIMM-N battery.
- 2 Using Phillips #2 screwdriver, remove the screw securing the NVDIMM-N battery.
- 3 Holding the edges, lift the NVDIMM-N battery at an angle to disengage it from the slot on the air shroud.
- 4 Lift the NVDIMM-N battery away from the system.

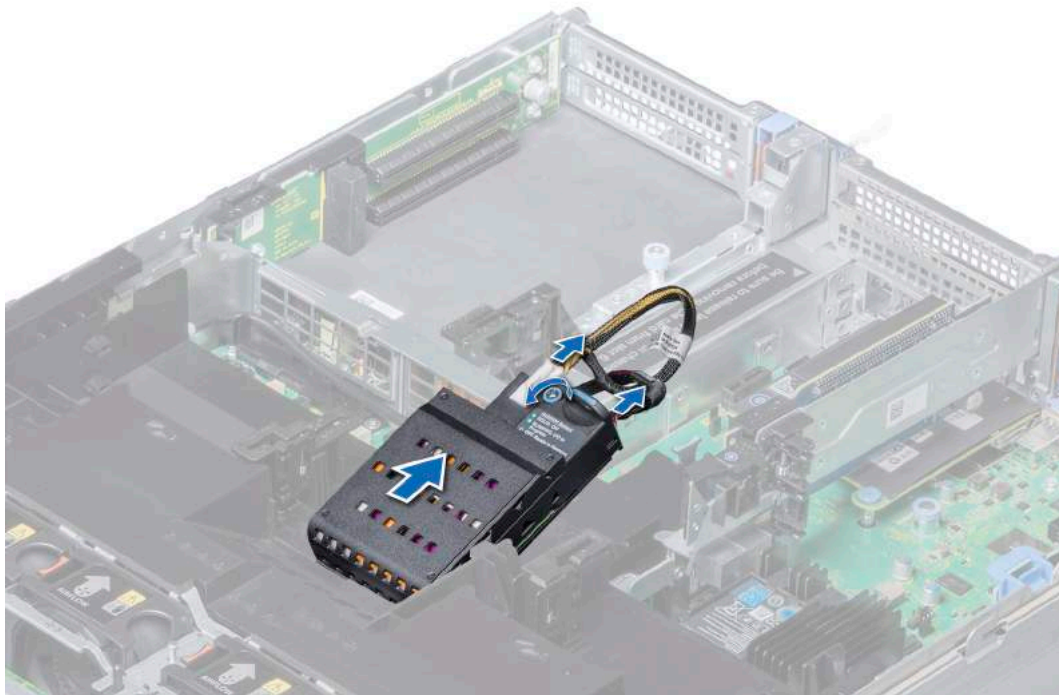

**Figure 33. Removing the NVDIMM-N battery from the air shroud**

#### Next step

Install the NVDIMM-N battery into the air shroud.

#### Related link

[Installing NVDIMM-N battery into air shroud](#)

## Installing NVDIMM-N battery into air shroud

#### Prerequisite

- 1 Follow the safety guidelines listed in [Safety instructions](#).

**CAUTION:** NVDIMM-N battery is not hot swappable. To prevent data loss and potential damage to your system, ensure that your system, LEDs on system, LEDs on NVDIMM-N and LEDs on NVDIMM-N battery are turned off before installing the NVDIMM-N battery.

**CAUTION:** To avoid damage to the battery connector, you must firmly support the connector while installing or removing a battery.

#### Steps

- 1 Incline the NVDIMM-N battery at an angle and place the battery on the air shroud slot.
- 2 Using Phillips #2 screwdriver, tighten the screw to secure the NVDIMM-N battery.
- 3 Connect the cables to the NVDIMM-N battery.

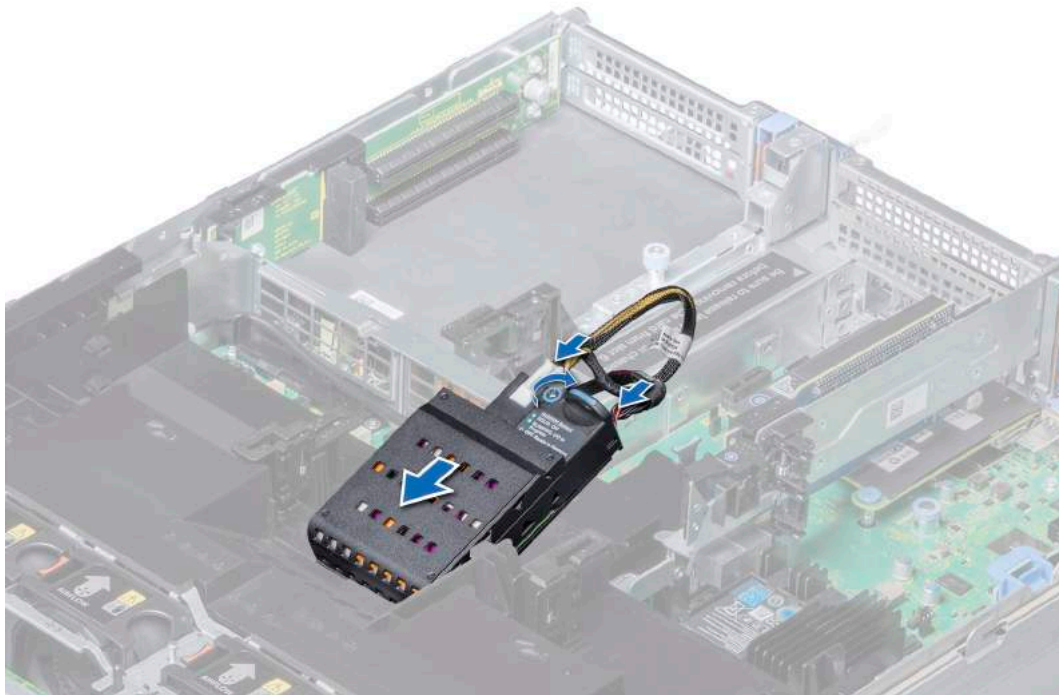

**Figure 34. Installing NVDIMM-N battery into air shroud**

#### **Next step**

Follow the procedure listed in [After working inside your system.](#)

## Removing NVDIMM-N battery from mid drive tray

#### **Prerequisites**

- 1 Follow the safety guidelines listed in [Safety instructions.](#)
- 2 Follow the procedure listed in [Before working inside your system.](#)

**CAUTION:** NVDIMM-N battery is not hot swappable. To prevent data loss and potential damage to your system, ensure that your system, LEDs on system, LEDs on NVDIMM-N and LEDs on NVDIMM-N battery are turned off before removing the NVDIMM-N battery.

**CAUTION:** To avoid damage to the battery connector, you must firmly support the connector while installing or removing a battery.

#### **Steps**

- 1 Lift the drive tray handles 90 degrees upward.
- 2 Using Phillips #2 screwdriver, remove the screw securing the NVDIMM-N battery.
- 3 Slide the NVDIMM-N battery to disengage it from the drive tray.
- 4 Disconnect the cables from the NVDIMM-N battery.
- 5 Holding the edges, lift the NVDIMM-N battery away from the system.



Figure 35. Removing NVDIMM-N battery from mid drive tray

#### Next step

Install NVDIMM-N battery into mid drive tray.

#### Related link

[Installing NVDIMM-N battery into mid drive tray](#)

## Installing NVDIMM-N battery into mid drive tray

#### Prerequisites

Follow the safety guidelines listed in [Safety instructions](#).

**CAUTION:** NVDIMM-N battery is not hot swappable. To prevent data loss and potential damage to your system, ensure that your system, LEDs on system, LEDs on NVDIMM-N and LEDs on NVDIMM-N battery are turned off before installing the NVDIMM-N battery.

**CAUTION:** To avoid damage to the battery connector, you must firmly support the connector while installing or removing a battery.

#### Steps

- 1 Connect the cables to the NVDIMM-N battery.
- 2 Slide the NVDIMM-N battery to engage the battery with the drive tray.
- 3 Using Phillips #2 screwdriver, tighten the screw to secure the NVDIMM-N battery.
- 4 Lower the drive tray handle.



Figure 36. Installing NVDIMM-N battery into mid drive tray

#### Next step

Follow the procedure listed in [After working inside your system](#).

## Removing NVDIMM-N battery from the bracket

#### Prerequisites

- 1 Follow the safety guidelines listed in [Safety instructions](#).
- 2 Follow the procedure listed in [Before working inside your system](#).

**CAUTION:** NVDIMM-N battery is not hot swappable. To prevent data loss and potential damage to your system, ensure that your system, LEDs on system, LEDs on NVDIMM-N and LEDs on NVDIMM-N battery are turned off before removing the NVDIMM-N battery.

**CAUTION:** To avoid damage to the battery connector, you must firmly support the connector while installing or removing a battery.

#### Step

Press the release tab and slide out the NVDIMM-N battery to disengage the tab on the battery from the slot on the bracket.





Figure 37. Removing NVDIMM-N battery from the bracket

#### Next step

- 1 Install NVDIMM-N battery into the bracket.

#### Related link

[Installing NVDIMM-N battery into the bracket](#)

## Installing NVDIMM-N battery into the bracket

#### Prerequisites

Follow the safety guidelines listed in [Safety instructions](#).

**CAUTION:** NVDIMM-N battery is not hot swappable. To prevent data loss and potential damage to your system, ensure that your system, LEDs on system, LEDs on NVDIMM-N and LEDs on NVDIMM-N battery are turned off before installing the NVDIMM-N battery.

**CAUTION:** To avoid damage to the battery connector, you must firmly support the connector while installing or removing a battery.

#### Steps

- 1 Align the tab on the NVDIMM-N battery with the slot on the bracket.
- 2 Insert the battery into the bracket until it is firmly seated.



**Figure 38. Installing NVDIMM-N battery into the bracket**

#### Next step

Follow the procedure listed in [After working inside your system](#).

## Mid drive tray

The mid drive tray is located behind the cooling fan assembly. It supports up to four 2.5 inch or four 3.5 inch drives.

**NOTE:** Systems that support the internal mid drive tray require low-profile heat sinks and do not require or support an air shroud.

## Removing mid drive tray

#### Prerequisites

- 1 Follow the safety guidelines listed in [Safety instructions](#).
- 2 Follow the procedure listed in [Before working inside your system](#).
- 3 Disconnect all the cables from the drive backplane.

**CAUTION:** The drive tray is hot to touch for some time after the system has been powered down. Allow time for the drive tray to cool before handling it.

#### Steps

- 1 Lift the drive tray handles 90 degrees upward.
- 2 Hold the drive tray handles, and lift the drive tray out of the system.

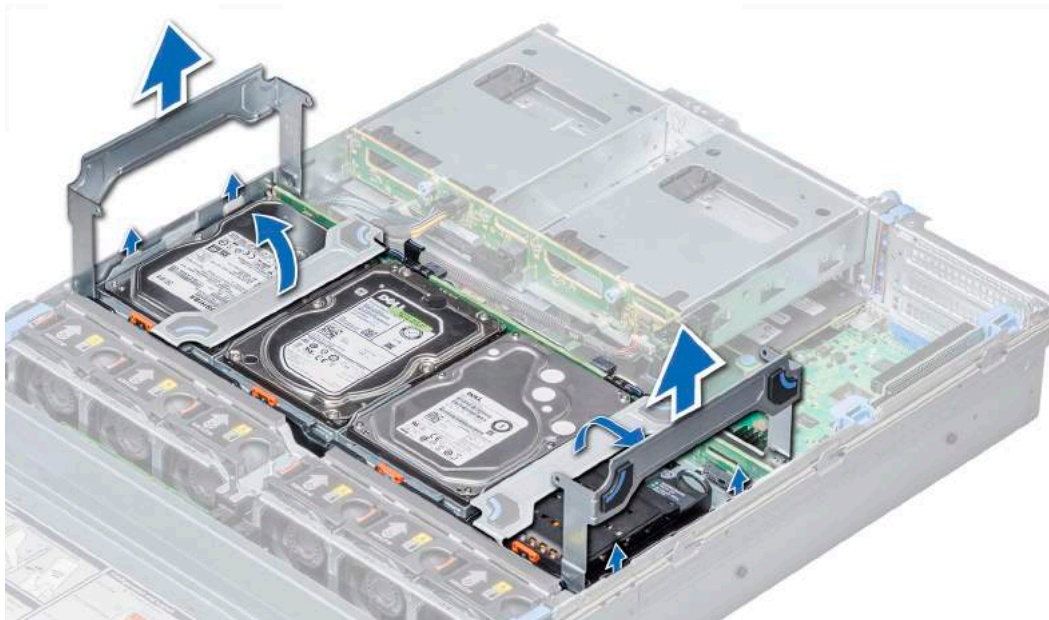

**Figure 39. Removing mid drive tray**

**Next step**

Install the mid drive tray.

**Related link**

[Installing the mid drive tray](#)

## Installing the mid drive tray

**Prerequisite**

- 1 Follow the safety guidelines listed in [Safety instructions](#).

**NOTE:** Systems that support the internal drive tray support low-profile heat sinks and do not support an air shroud.

**Steps**

- 1 Lift the drive tray handles to 90 degrees upward.
- 2 Hold the drive tray handles, and align the slots on the drive tray with the guide pins on the system.
- 3 Lower the drive tray into the system.
- 4 Lower the drive tray handles to lock the drive tray in place.



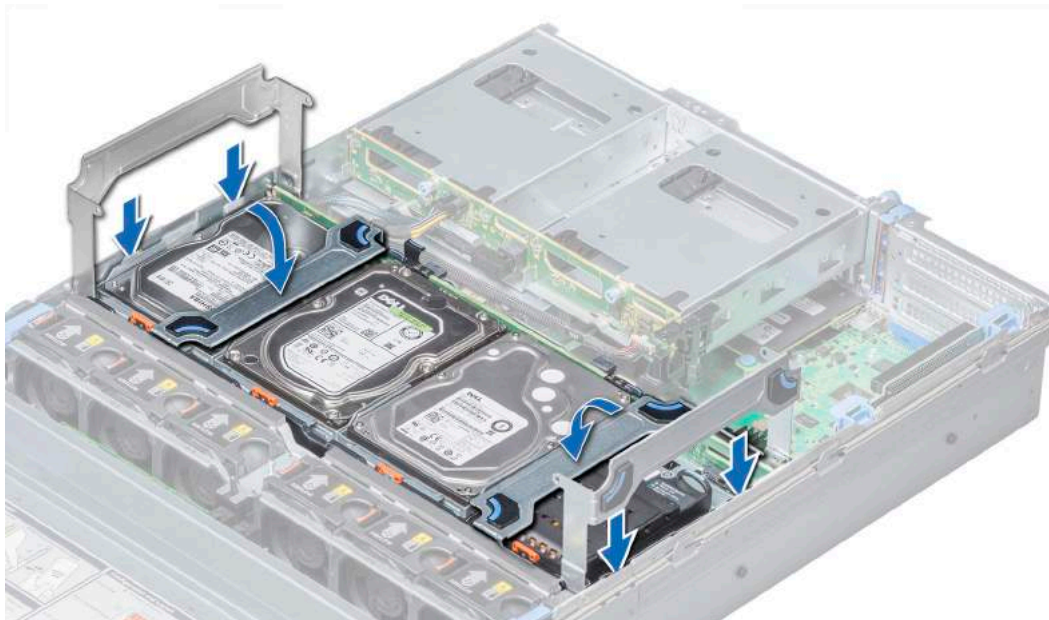

**Figure 40. Installing the mid drive tray**

#### Next steps

- 1 Connect all the cables to the backplane.
- 2 Follow the procedure listed in [After working inside your system](#).

## Removing drive blank from drive carrier

The procedure to remove drive blank from drive carrier is identical to removal of drive from drive carrier. The procedure for removing 2.5 inch and 3.5 inch blanks from drive carriers is identical.

#### Prerequisites

- 1 Follow the safety guidelines listed in [Safety instructions](#).
- 2 Follow the procedure listed in [Before working inside your system](#).

**⚠ CAUTION: To maintain proper system cooling, all empty drive slots must have drive blanks installed.**

**⚠ CAUTION: Mixing drive blanks from previous generations of PowerEdge servers is not supported.**

#### Steps

- 1 Push out at the edges of the drive carrier to disengage the tabs on the drive carrier from the slots on the drive blank.
- 2 Lift the drive carrier away from the drive blank.

#### Next step

Install drive blank into drive carrier.

#### Related link

[Installing drive blank into the drive carrier](#)

# Installing drive blank into the drive carrier

The procedure to install drive blank from drive carrier is identical to installation of drive into drive carrier. The procedure for installing 2.5 inch and 3.5 inch blanks into drive carriers is identical.

## Prerequisites

- 1 Follow the safety guidelines listed in [Safety instructions](#).

**△ CAUTION:** To maintain proper system cooling, all empty drive slots must have drive blanks installed.

**△ CAUTION:** Mixing drive blanks from previous generations of PowerEdge servers is not supported.

## Steps

- 1 Align the tabs on the drive carrier with the slots on the drive blank.
- 2 Pull the edges of the carrier to fit over the drive blank.
- 3 Lower the drive carrier onto the drive blank to secure it.

## Next step

Follow the procedure listed in [After working inside your system](#).

# Removing drive carrier from the mid drive tray

## Prerequisites

- 1 Follow the safety guidelines listed in [Safety instructions](#).
- 2 Follow the procedure listed in [Before working inside your system](#).
- 3 From the management software, prepare the drive for removal. Wait until the indicators on the drive carrier signal that the drive can be removed safely. For more information, see the documentation for the storage controller at [Dell.com/storagecontrollermanuals](http://Dell.com/storagecontrollermanuals).

If the drive is online, the green activity/fault indicator flashes as the drive is turned off. When the drive indicators are off, the drive is ready for removal.

**△ CAUTION:** To prevent data loss, ensure that your operating system supports hot-swap drive installation. See the documentation supplied with your operating system.

**△ CAUTION:** When a replacement hot swappable drive is installed and the system is powered on, the drive automatically begins to rebuild. Ensure that the replacement drive is blank or contains data that you wish to overwrite. Any data on the replacement drive is immediately lost after the drive is installed.

**△ CAUTION:** Mixing drive carriers from previous generations of PowerEdge servers is not supported.

## Steps

- 1 Lift the drive carrier handle upward.
- 2 Press the release tab on the drive tray and lift the drive carrier handle upward to disengage the drive from the backplane.
- 3 Hold the drive carrier handle and lift the drive carrier out of the drive tray.

**△ CAUTION:** To maintain proper system cooling, all empty drive slots must have drive blanks installed.

- 4 If you are not replacing the drive immediately, insert a drive blank in the empty drive slot.

**① NOTE:** Install the drive blanks in the drive carrier before installing the drive carrier into the drive tray.

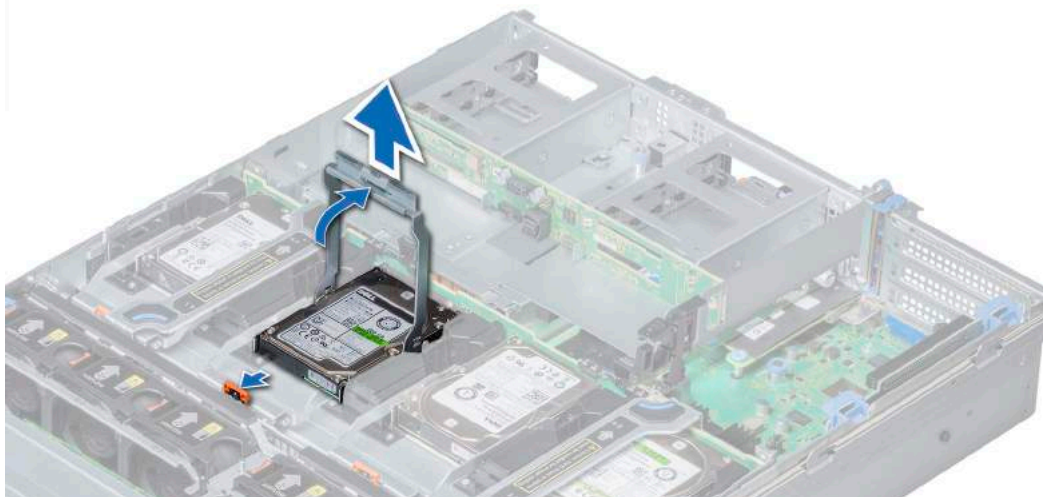

Figure 41. Removing drive carrier from the mid drive tray

#### Next step

Install drive carrier into mid drive tray.

#### Related link

[Installing drive carrier into mid drive tray](#)

## Installing drive carrier into mid drive tray

#### Prerequisites

Follow the safety guidelines listed in [Safety instructions](#).

⚠ **CAUTION:** Use only drives that have been tested and approved for use with the drive backplane.

⚠ **CAUTION:** When installing a drive, ensure that the adjacent drives are fully installed. Inserting a drive carrier and attempting to lock its handle next to a partially installed carrier can damage the partially installed carrier's shield spring and make it unusable.

⚠ **CAUTION:** To prevent data loss, ensure that your operating system supports hot-swap drive installation. See the documentation supplied with your operating system.

⚠ **CAUTION:** Mixing drive carriers from previous generations of PowerEdge servers is not supported.

⚠ **CAUTION:** When a replacement hot swappable drive is installed and the system is powered on, the drive automatically begins to rebuild. Ensure that the replacement drive is blank or contains data that you wish to overwrite. Any data on the replacement drive is immediately lost after the drive is installed.

#### Steps

- 1 Lift the carrier handle.
- 2 If a drive blank is installed in the drive slot, remove it.
- 3 Insert the drive carrier into the drive tray.
- 4 Lower the drive carrier handle to engage the drive to the connector on the backplane and lock the drive in place.

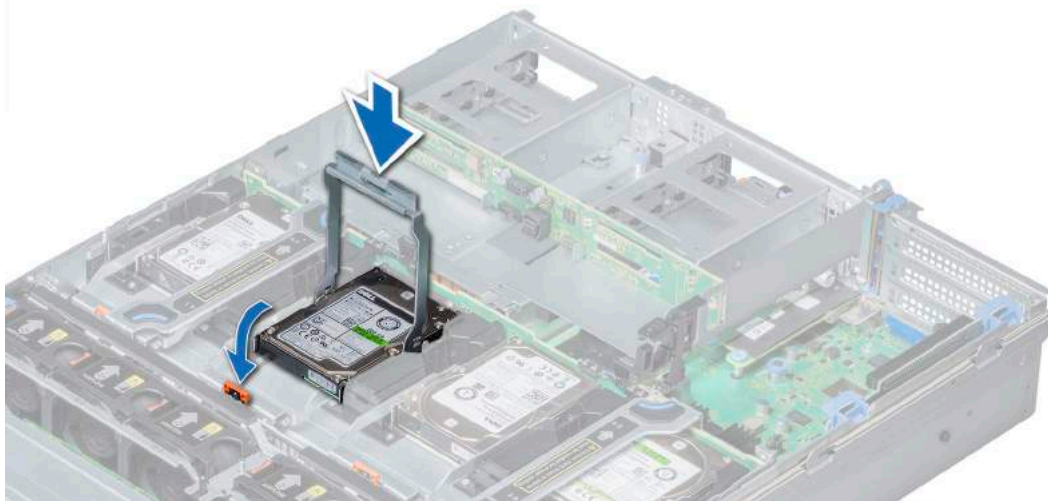

Figure 42. Installing drive carrier into mid drive tray

#### Next step

Follow the procedure listed in [After working inside your system](#).

## Removing 3.5 inch drive from the drive carrier

#### Prerequisites

- 1 Follow the safety guidelines listed in [Safety instructions](#).
- 2 Follow the procedure listed in [Before working inside your system](#).

**⚠ CAUTION: Mixing drives from previous generations of PowerEdge servers is not supported.**

**⚠ CAUTION: To maintain proper system cooling, all empty drive slots must have drive blanks installed.**

#### Steps

- 1 Push out at the edges of the carrier to disengage the tabs on the drive carrier from the slots on the drive.
- 2 Lift the drive carrier away from the drive.

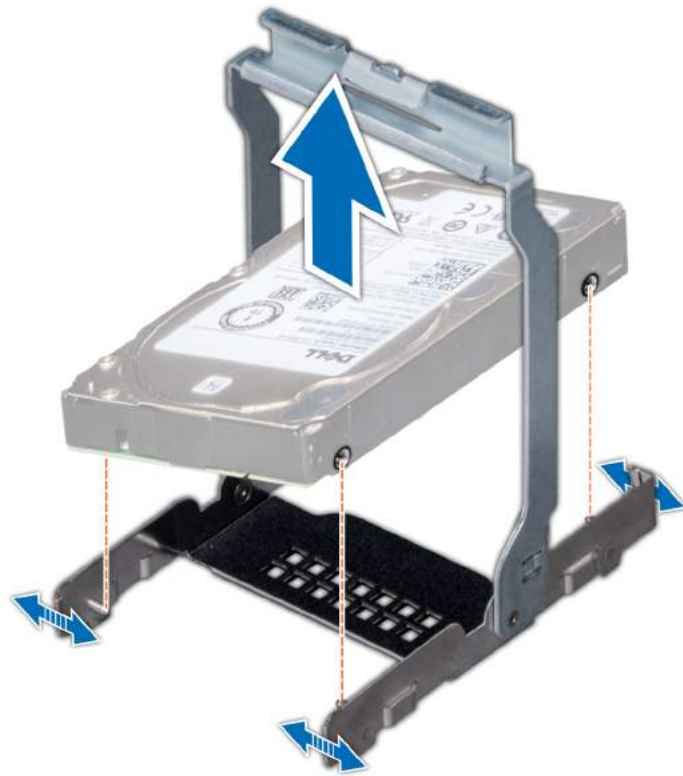

Figure 43. Removing 3.5 inch drive from the drive carrier

**Next step**

Install 3.5 inch drive into the drive carrier.

**Related link**

[Installing 3.5 inch drive into the drive carrier](#)

## Installing 3.5 inch drive into the drive carrier

**Prerequisite**

Follow the safety guidelines listed in [Safety instructions](#).

**⚠ CAUTION: Mixing drives from previous generations of PowerEdge servers is not supported.**

**Steps**

- 1 Align the tabs on the drive carrier with the slots on the drive.
- 2 Pull the edges of the carrier to fit over the drive.
- 3 Lower the drive carrier onto the drive to secure it.

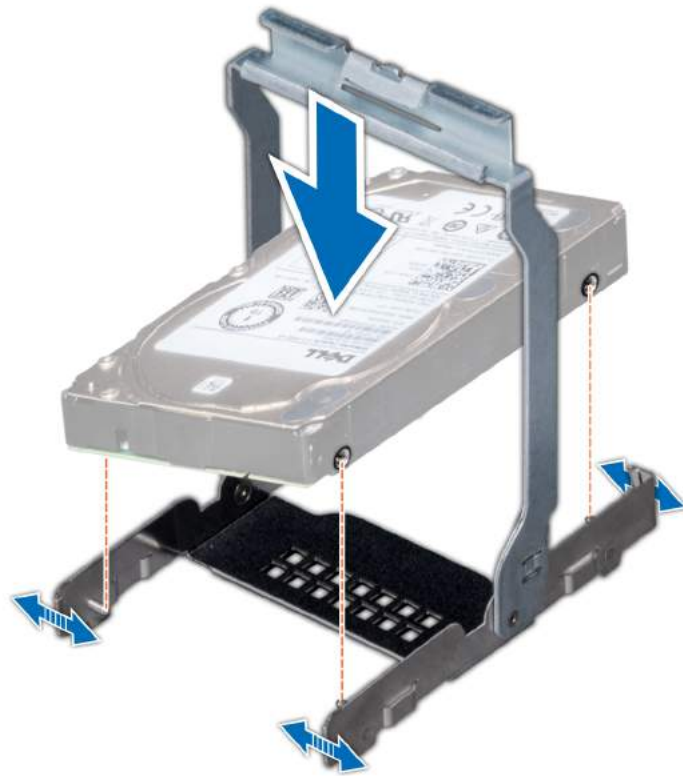

Figure 44. Installing 3.5 inch drive into the drive carrier

**Next step**

Follow the procedure listed in [After working inside your system](#).

## Removing 2.5 inch drive from the 3.5 inch drive adapter

**Prerequisites**

- 1 Follow the safety guidelines listed in [Safety instructions](#).
- 2 Follow the procedure listed in [Before working inside your system](#).
- 3 Remove 3.5 inch drive adapter from the 3.5 inch drive carrier.

**NOTE:** A 2.5 inch hot swappable drive is installed in a 3.5 inch drive adapter, which is then installed in the 3.5 inch hot swappable drive carrier.

**Steps**

- 1 Using Phillips #2 screwdriver, remove the screws from the side of the 3.5 inch drive adapter.
- 2 Remove the drive from the 3.5 inch drive adapter.





**Figure 45. Removing 2.5 inch drive from the 3.5 inch drive adapter**

**Next step**

Install 2.5 inch drive into the 3.5 inch drive adapter.

**Related link**

[Removing 3.5 inch drive adapter from 3.5 inch drive carrier](#)

[Installing 2.5 inch drive into the 3.5 inch drive adapter](#)

## Installing 2.5 inch drive into the 3.5 inch drive adapter

**Prerequisite**

Follow the safety guidelines listed in [Safety instructions](#).

**Steps**

- 1 Align the screw holes on the 2.5 inch drive with the screw holes on the 3.5 inch drive adapter.
- 2 Using Phillips #2 screwdriver, install the screws to secure the drive to the 3.5 inch drive adapter.



**Figure 46. Installing 2.5 inch drive into the 3.5 inch drive adapter**

#### Next steps

- 1 Install 3.5 inch adapter into the 3.5 inch drive carrier.
- 2 Follow the procedure listed in [After working inside your system](#).

#### Related link

[Installing 3.5 inch drive into the drive carrier](#)

## Removing 3.5 inch drive adapter from 3.5 inch drive carrier

#### Prerequisites

- 1 Follow the safety guidelines listed in [Safety instructions](#).
- 2 Follow the procedure listed in [Before working inside your system](#).

**⚠ CAUTION: To maintain proper system cooling, all empty drive slots must have drive blanks installed.**

#### Steps

- 1 Push out at the edges of the carrier to disengage the tabs on the drive carrier from the slots on the drive.
- 2 Lift the drive carrier away from the drive.



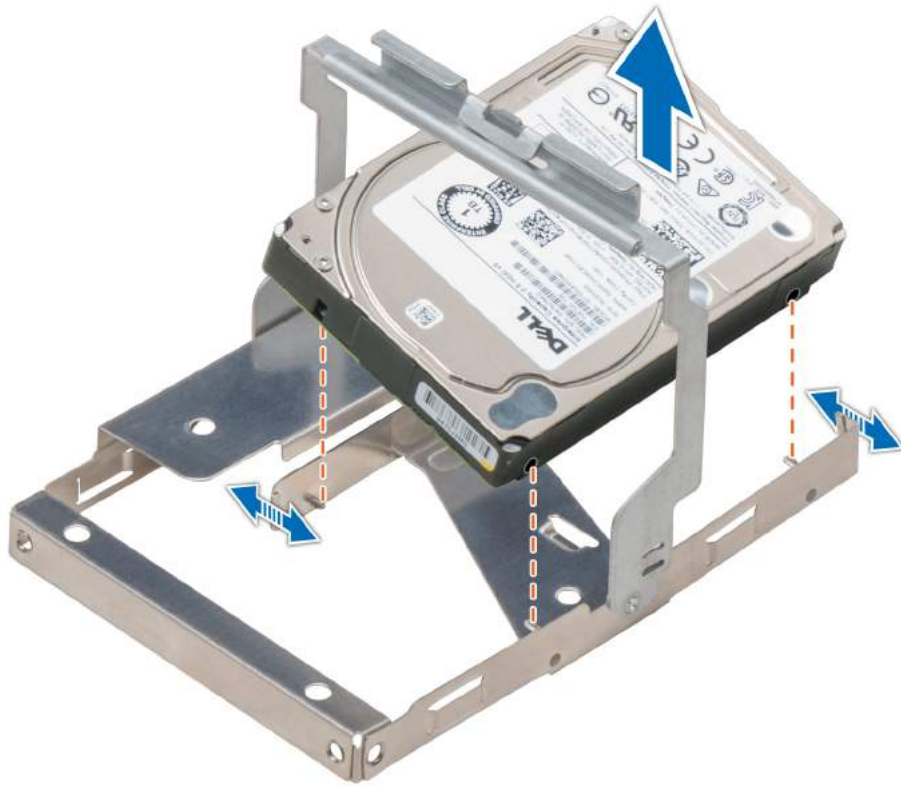

**Figure 47. Removing 3.5 inch drive adapter from 3.5 inch drive carrier**

**Next step**

Install 3.5 inch drive adapter into 3.5 inch drive carrier.

**Related link**

[Installing 3.5 inch drive adapter into the drive carrier](#)

## Installing 3.5 inch drive adapter into the drive carrier

**Prerequisite**

Follow the safety guidelines listed in [Safety instructions](#).

**Steps**

- 1 Align the tabs on the drive carrier with the slots on the drive.
- 2 Pull the edges of the carrier to fit over the drive.
- 3 Lower the drive carrier onto the drive to secure it.

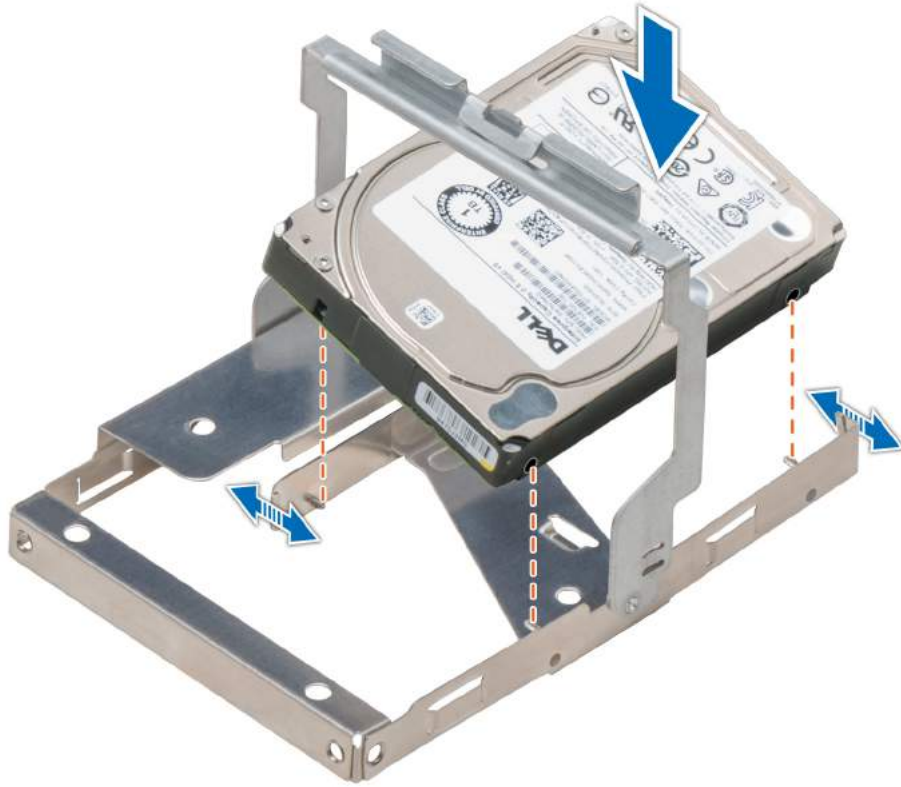

Figure 48. Installing 3.5 inch drive adapter into the drive carrier

#### Next step

Follow the procedure listed in [After working inside your system](#).

## Drives

Drives are supplied in hot swappable drive carriers that fit in the drive slots.

**CAUTION:** Before attempting to remove or install a drive while the system is running, see the documentation for the storage controller card to ensure that the host adapter is configured correctly.

**CAUTION:** Do not turn off or restart your system while a drive is being formatted. Doing so can cause a drive failure.

When you format a drive, allow enough time for the formatting to complete. Be aware that high-capacity drives can take a long time to format.

## Removing a drive blank

The procedure for removing 2.5 inch and 3.5 inch drive blanks is identical.

#### Prerequisites

- 1 Follow the safety guidelines listed in [Safety instructions](#).
- 2 If installed, remove the front bezel.

**△ CAUTION:** To maintain proper system cooling, drive blanks must be installed in all empty drive slots.

**△ CAUTION:** Mixing drive blanks from previous generations of PowerEdge servers is not supported.

#### Step

Press the release button, and slide the drive blank out of the drive slot.



**Figure 49. Removing a drive blank**

#### Next steps

- Follow the procedure listed in [After working inside your system](#).
- Install a drive or a drive blank.

#### Related link

[Removing the optional front bezel](#)

[Installing a drive carrier](#)

[Installing a drive blank](#)

## Installing a drive blank

The procedure for installing 2.5 inch and 3.5 inch drive blanks is identical.

#### Prerequisite

Follow the safety guidelines listed in [Safety instructions](#).

**△ CAUTION:** Mixing drive blanks from previous generations of PowerEdge servers is not supported.

#### Step

Insert the drive blank into the drive slot, and push the blank until the release button clicks into place.



Figure 50. Installing a drive blank

#### Next step

If removed, install the front bezel.

#### Related link

[Installing the optional front bezel](#)

## Removing a drive carrier

#### Prerequisites

- 1 Follow the safety guidelines listed in .
- 2 If applicable, remove the front bezel.
- 3 Using the management software, prepare the drive for removal.

If the drive is online, the green activity or fault indicator flashes while the drive is turning off. When the drive indicators are off, the drive is ready for removal. For more information, see the documentation for the storage controller.

- ⚠ **CAUTION:** Before attempting to remove or install a drive while the system is running, see the documentation for the storage controller card to ensure that the host adapter is configured correctly to support drive removal and insertion.
- ⚠ **CAUTION:** Mixing drives from previous generations of PowerEdge servers is not supported.
- ⚠ **CAUTION:** To prevent data loss, ensure that your operating system supports drive installation. See the documentation supplied with your operating system.

#### Steps

- 1 Press the release button to open the drive carrier release handle.
- 2 Holding the handle, slide the drive carrier out of the drive slot.



**Figure 51. Removing a drive carrier**

#### Next steps

- 1 Follow the procedure listed in [After working inside your system](#).
- 2 Install a drive carrier.
- 3 If you are not replacing the drive immediately, insert a drive blank in the empty drive slot to maintain proper system cooling.

#### Related link

- [Removing the optional front bezel](#)
- [Installing a drive carrier](#)

## Installing a drive carrier

#### Prerequisites

- ⚠ **CAUTION:** Before attempting to remove or install a drive while the system is running, see the documentation for the storage controller card to ensure that the host adapter is configured correctly to support drive removal and insertion.
- ⚠ **CAUTION:** Mixing drives from previous generations of PowerEdge servers is not supported.
- ⚠ **CAUTION:** Combining SAS and SATA drives in the same RAID volume is not supported.
- ⚠ **CAUTION:** When installing a drive, ensure that the adjacent drives are fully installed. Inserting a drive carrier and attempting to lock its handle next to a partially installed carrier can damage the partially installed carrier's shield spring and make it unusable.
- ⚠ **CAUTION:** To prevent data loss, ensure that your operating system supports hot-swap drive installation. See the documentation supplied with your operating system.
- ⚠ **CAUTION:** When a replacement hot swappable drive is installed and the system is powered on, the drive automatically begins to rebuild. Ensure that the replacement drive is blank or contains data that you wish to overwrite. Any data on the replacement drive is immediately lost after the drive is installed.

- 1 Follow the safety guidelines listed in .
- 2 If applicable, remove the drive blank.

## Steps

- 1 Press the release button on the front of the drive carrier to open the release handle.
- 2 Insert the drive carrier into the drive slot and slide until the drive connects with the backplane.
- 3 Close the drive carrier release handle to lock the drive in place.



Figure 52. Installing a drive carrier

## Next step

If applicable, install the front bezel.

## Related link

[Installing the optional front bezel](#)

# Removing the drive from the drive carrier

## Prerequisite

**⚠ CAUTION: Mixing drives from previous generations of PowerEdge servers is not supported.**

## Steps

- 1 Using Phillips #1 screwdriver, remove the screws from the slide rails on the drive carrier.
- 2 Lift the drive out of the drive carrier.



**Figure 53. Removing the drive from the drive carrier**

**Next step**

If applicable, install the drive into the drive carrier.

**Related link**

[Installing a drive into the drive carrier](#)

## Installing a drive into the drive carrier

**Prerequisite**

**⚠ CAUTION: Mixing drive carriers from other generations of PowerEdge servers is not supported.**

**Steps**

- 1 Insert the drive into the drive carrier with the connector end of the drive towards the back of the carrier.
- 2 Align the screw holes on the drive with the screws holes on the drive carrier.  
When aligned correctly, the back of the drive is flush with the back of the drive carrier.
- 3 Using the Phillips #1 screwdriver, secure the drive to the drive carrier with screws.





**Figure 54. Installing a drive into the drive carrier**

## Rear drive cage

The drive cage supports up to four 2.5 inch or two 3.5 inch drives.

## Removing rear drive cage

The procedure for removing 2.5 inch and 3.5 inch drive cages is identical.

### Prerequisites

- 1 Follow the safety guidelines listed in [Safety instructions](#).
- 2 Follow the procedure listed in [Before working inside your system](#).
- 3 Remove all the drives.
- 4 Disconnect all the cables from the rear drive backplane.
- 5 Remove the rear drive backplane.

### Steps

- 1 Using Phillips #2 screwdriver, loosen the screws that secure the drive cage to the system.
- 2 Hold the drive cage by its sides, and lift it away from the system.



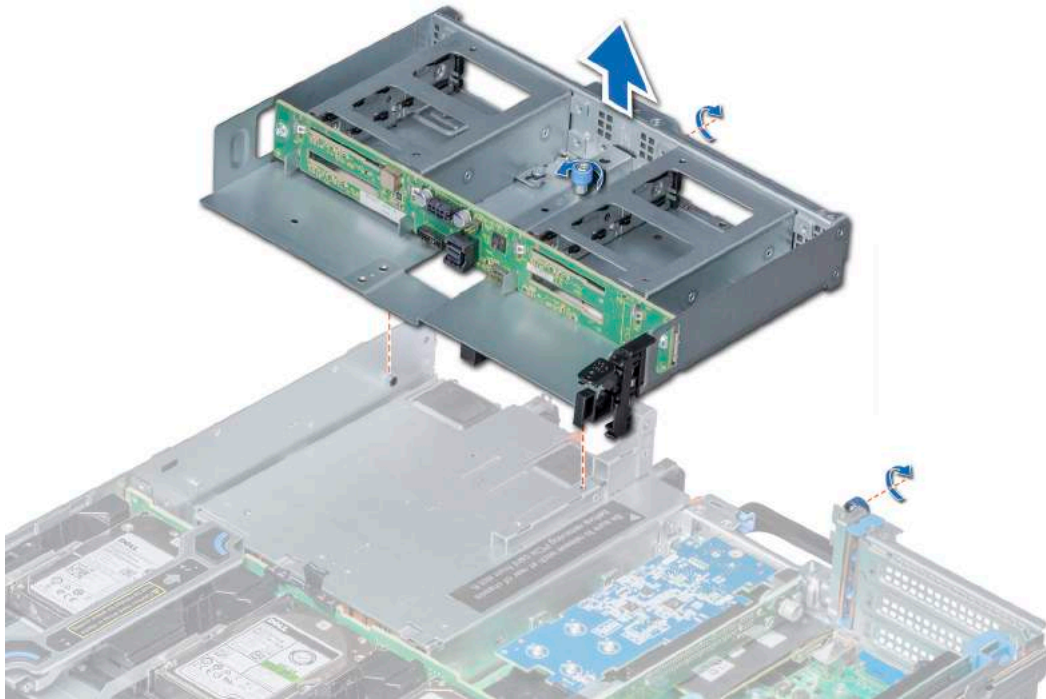

Figure 55. Removing 4 x 2.5 inch rear drive cage

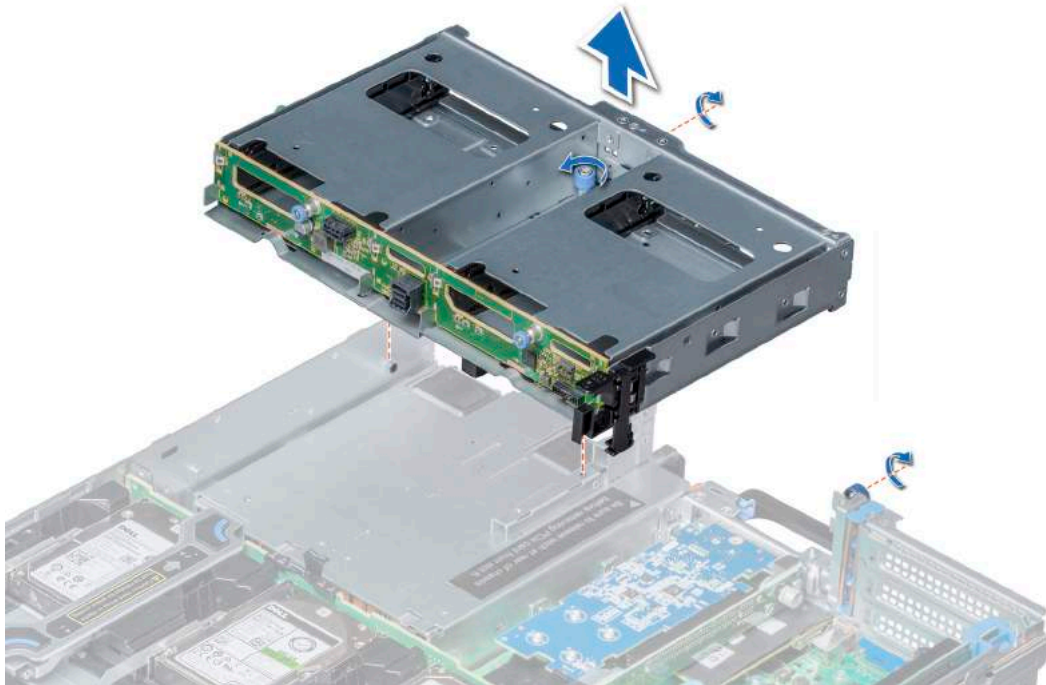

Figure 56. Removing 2 x 3.5 inch drive rear cage

**Next step**

Install the rear drive cage.

**Related link**

- [Removing a drive carrier](#)
- [Removing 3.5 inch drive backplane \(rear\)](#)
- [Removing the 2.5 inch drive backplane \(rear\)](#)
- [Installing rear drive cage](#)

## Installing rear drive cage

The procedure for installing 2.5 inch and 3.5 inch rear drive cages is identical.

**Prerequisite**

Follow the safety guidelines listed in [Safety instructions](#).

**Steps**

- 1 Align the screws on the drive cage with the screw holes on the system.
- 2 Lower the drive cage into the system until it is firmly seated.
- 3 Using Phillips #2 screwdriver, tighten the screws to secure the drive cage to the system.

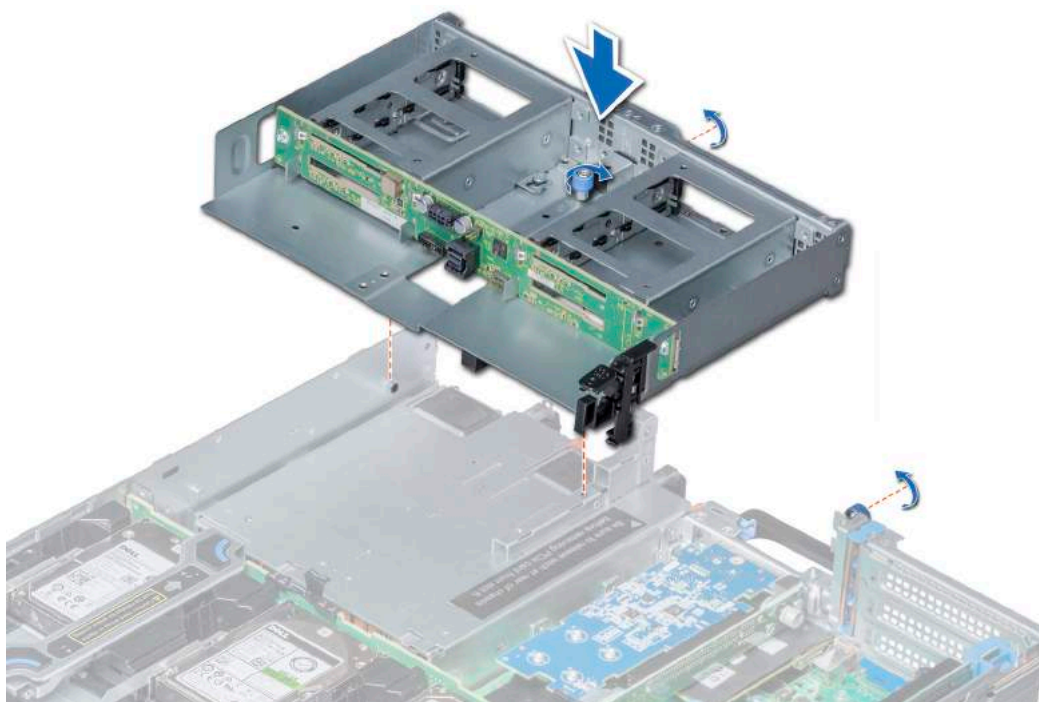

**Figure 57. Installing 4 x 2.5 inch rear drive cage**

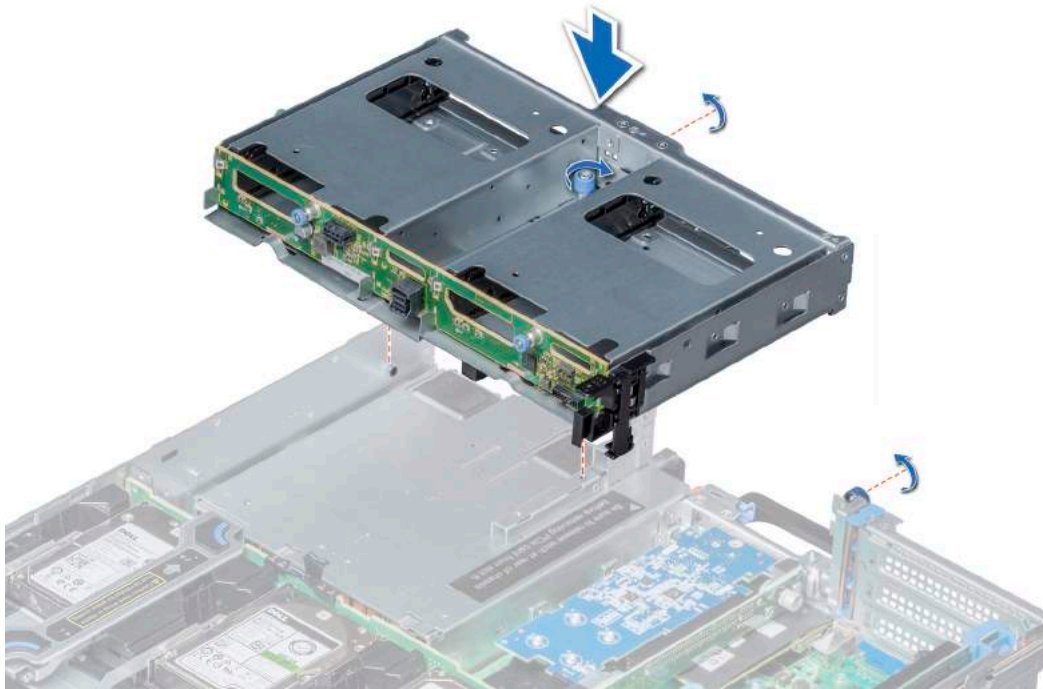

**Figure 58. Installing 2 x 3.5 inch rear drive cage**

#### Next steps

- 1 Install the rear drive backplane.
- 2 Connect all the cables to the rear drive backplane.
- 3 Install all the drives.
- 4 Follow the procedure listed in [After working inside your system](#).

#### Related link

- [Installing 3.5 inch drive backplane \(rear\)](#)
- [Installing the 2.5 inch drive backplane \(rear\)](#)
- [Installing a drive carrier](#)

## System memory

The system supports DDR4 registered DIMMs (RDIMMs), load reduced DIMMs (LRDIMMs) and non-volatile dual in-line DIMM-Ns (NVDIMM-Ns). System memory holds the instructions that are executed by the processor.

**NOTE:** MT/s indicates DIMM speed in MegaTransfers per second.

Memory bus operating frequency can be 2666 MT/s, 2400 MT/s, or 2133 MT/s depending on the following factors:

- DIMM type (RDIMM or LRDIMM)
- Number of DIMMs populated per channel
- System profile selected (for example, Performance Optimized, or Custom [can be run at high speed or lower])
- Maximum supported DIMM frequency of the processors

Your system contains 24 memory sockets split into two sets of 12 sockets, one set per processor. Each 12-socket set is organized into six channels. In each channel, the release tabs of the first socket are marked white, and the second socket black.

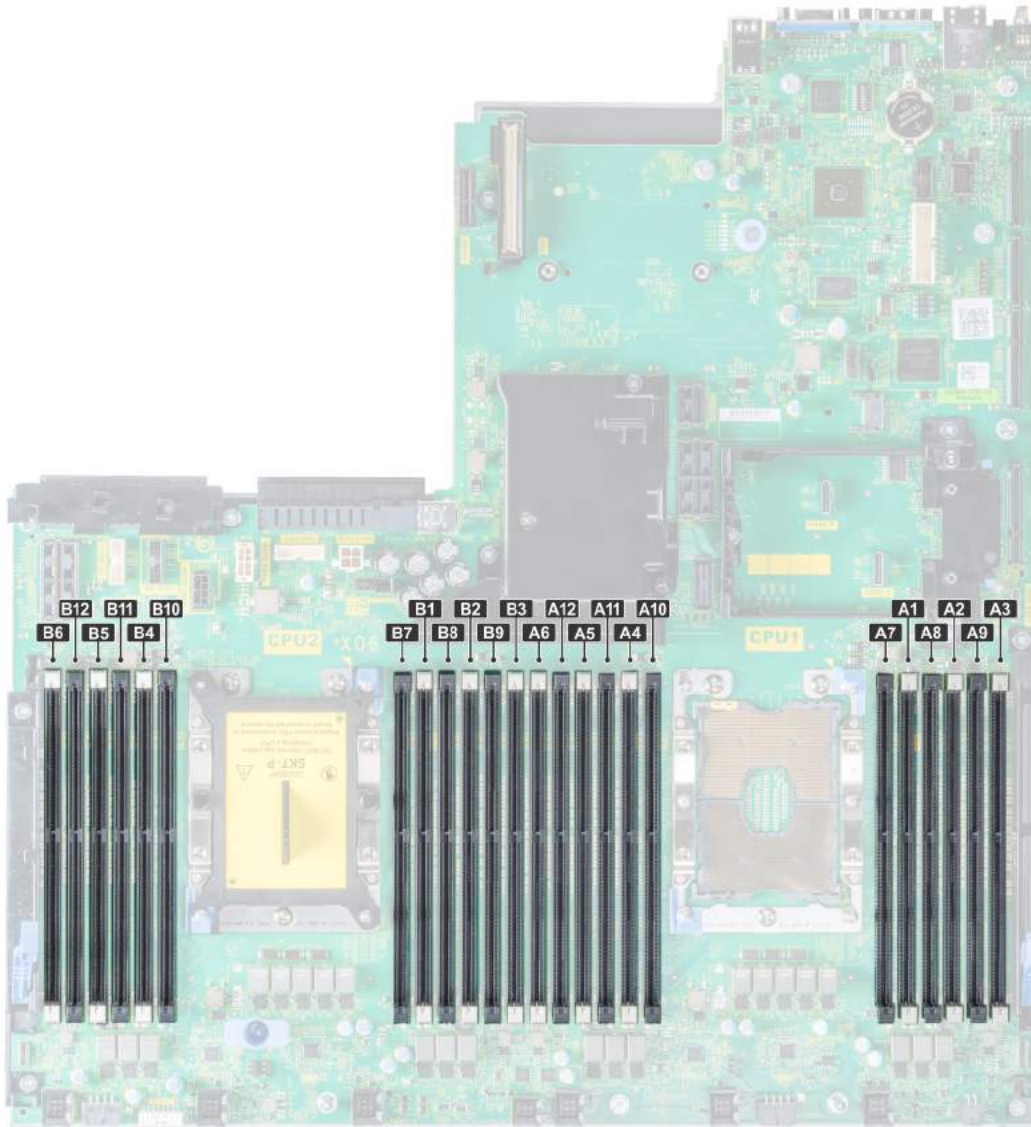

**Figure 59. Memory socket locations**

Memory channels are organized as follows:

**Table 38. Memory channels**

Processor	Channel 0	Channel 1	Channel 2	Channel 3	Channel 4	Channel 5
Processor 1	Slots A1 and A7	Slots A2 and A8	Slots A3 and A9	Slots A4 and A10	Slots A5 and A11	Slots A6 and A12
Processor 2	Slots B1 and B7	Slots B2 and B8	Slots B3 and B9	Slots B4 and B10	Slots B5 and B11	Slots B6 and B12



# General memory module installation guidelines

**NOTE:** If your system's memory configurations fail to observe these guidelines, your system might not boot, might stop responding during memory configuration, or might operate with reduced memory.

The system supports Flexible Memory Configuration, enabling the system to be configured and run in any valid chipset architectural configuration. The following are the recommended guidelines for installing memory modules:

- RDIMMs and LRDIMMs must not be mixed.
- x4 and x8 DRAM based memory modules can be mixed. For more information, see the Mode-specific guidelines section.
- Up to two RDIMMs can be populated per channel regardless of rank count.
- Up to two LRDIMMs can be populated per channel regardless of rank count.
- If memory modules with different speeds are installed, they will operate at the speed of the slowest installed memory module(s) or slower depending on the system DIMM configuration.
- Populate memory module sockets only if a processor is installed. For single-processor systems, sockets A1 to A12 are available. For dual-processor systems, sockets A1 to A12 and sockets B1 to B12 are available.
- Populate all the sockets with white release tabs first, followed by the black release tabs.
- When mixing memory modules with different capacities, populate the sockets with memory modules with the highest capacity first. For example, if you want to mix 8 GB and 16 GB memory modules, populate 16 GB memory modules in the sockets with white release tabs and 8 GB memory modules in the sockets with black release tabs.
- In a dual-processor configuration, the memory configuration for each processor should be identical. For example, if you populate socket A1 for processor 1, then populate socket B1 for processor 2, and so on.
- Memory modules of different capacities can be mixed provided other memory population rules are followed (for example, 8 GB and 16 GB memory modules can be mixed).
- Mixing of more than two memory module capacities in a system is not supported.
- Populate six memory modules per processor (one DIMM per channel) at a time to maximize performance.

## Related link

[Mode-specific guidelines](#)

# NVDIMM-N memory module installation guidelines

The following are the recommended guidelines for installing NVDIMM-N memory modules:

- Each system supports memory configurations with 1, 2, 4, 6, or 12 NVDIMM-Ns.
- Supported configurations have dual processors and a minimum of 12x RDIMMs.
- LRDIMMs and NVDIMM-Ns must not be mixed.
- Maximum of 12 NVDIMM-Ns can be installed in a system.

For more information on the supported NVDIMM-N configurations, see the *NVDIMM-N User Guide* at [Dell.com/poweredgemanuals](http://Dell.com/poweredgemanuals).

# Mode-specific guidelines

Six memory channels are allocated to each processor. The configurations allowed depend on the memory mode selected.

## Memory optimized (independent channel) mode

This mode supports Single Device Data Correction (SDDC) only for memory modules that use x4 device width. It does not impose any specific slot population requirements.

## Memory sparing

**NOTE:** To use memory sparing, this feature must be enabled in BIOS menu of System Setup.

**Table 39. Memory sparing**

Memory sparing (Single Rank)	Memory sparing allocates one rank per channel as a spare. If excessive correctable errors occur in a rank or channel, they are moved to the spare area while the operating system is running to prevent errors from causing an uncorrectable failure. Requires population of two ranks or more per channel.
Memory sparing (Multi Rank)	Memory sparing allocates two ranks per channel as a spare. If excessive correctable errors occur in a rank or channel, they are moved to the spare area while the operating system is running to prevent errors from causing an uncorrectable failure. Requires population of three ranks or more per channel.

With single rank memory sparing enabled, the system memory available to the operating system is reduced by one rank per channel. For example, in a dual-processor configuration with twenty four 16 GB dual-rank memory modules, the available system memory is:  $3/4$  (ranks/channel)  $\times$  24 (memory modules)  $\times$  16 GB = 288 GB, and not  $24$  (memory modules)  $\times$  16 GB = 384 GB. This calculation changes based on if it is single rank sparing or multi rank sparing. For multi rank sparing, the multiplier changes to  $1/2$  (ranks/channel).

**NOTE:** Memory sparing does not offer protection against a multi-bit uncorrectable error.

## Memory mirroring

Memory mirroring offers the strongest memory module reliability mode, providing improved uncorrectable multi-bit failure protection. In a mirrored configuration, the total available system memory is one half of the total installed physical memory. Half of the installed memory is used to mirror the active memory modules. In the event of an uncorrectable error, the system switches over to the mirrored copy. This ensures Single Device Data Correction (SDDC) and multi-bit protection.

The installation guidelines for memory modules are as follows:

- Memory modules must be identical in size, speed, and technology.
- Memory modules must be populated in sets of 6 per CPU to enable memory mirroring.

**Table 40. Memory population rules**

Processor	Configuration	Memory population	Memory population information
Single CPU	Optimizer (Independent channel) population order	1, 2, 3, 4, 5, 6, 7, 8, 9, 10, 11, 12	Populate in this order, odd amount allowed.
	Mirror population order	{1, 2, 3, 4, 5, 6}, {7, 8, 9, 10, 11, 12}	Mirroring is supported with 6 or 12 DIMMs per CPU.
	Single rank spare population order	1, 2, 3, 4, 5, 6, 7, 8, 9, 10, 11, 12	Populate in this order, odd amount allowed. Requires two ranks or more per channel.

Processor	Configuration	Memory population	Memory population information
	Multi rank spare population order	1, 2, 3, 4, 5, 6, 7, 8, 9, 10, 11, 12	Populate in this order, odd amount allowed. Requires three ranks or more per channel.
	Fault resilient population order	{1, 2, 3, 4, 5, 6}, {7, 8, 9, 10, 11, 12}	Supported with 6 or 12 DIMMs per CPU.
Dual CPU (Starting with CPU1, CPU1 and CPU2 population should match)	Optimized (Independent channel) population order	C1{1}, C2{1}, C1{2}, C2{2}, C1{3}, C2{3}...	Odd amount of DIMMs per CPU allowed.
	Mirroring population order	C1{1, 2, 3, 4, 5, 6}, C2{1, 2, 3, 4, 5, 6}, C1{7, 8, 9, 10, 11, 12}, C2{7, 8, 9, 10, 11, 12}	Mirroring is supported with 6 or 12 DIMMs per CPU.
	Single rank sparing population order	C1{1}, C2{1}, C1{2}, C2{2}, C1{3}, C2{3}...	Populate in this order, odd amount per CPU allowed. Requires two ranks or more per channel.
	Multi rank spare population order	C1{1}, C2{1}, C1{2}, C2{2}, C1{3}, C2{3}, C1{4}, C2{4}, C1{5}, C2{5}...	Populate in this order, odd amount per CPU allowed. Requires three ranks or more per channel.
	Fault resilient population order	C1{1, 2, 3, 4, 5, 6}, C2{1, 2, 3, 4, 5, 6}, C1{7, 8, 9, 10, 11, 12}, C2{7, 8, 9, 10, 11, 12}	Supported with 6 or 12 DIMMs per CPU.

## Removing a memory module

The procedure for removing a memory module and NVDIMM-N is identical.

### Prerequisites

- 1 Follow the safety guidelines listed in [Safety instructions](#).
- 2 Follow the procedure listed in [Before working inside your system](#).

**CAUTION:** To prevent data loss and potential damage to your system, ensure that your system, LEDs on system, LEDs on NVDIMM-N and LEDs on NVDIMM-N battery are turned off before removing the NVDIMM-N battery.

- 3 If applicable, remove the air shroud.
- 4 If applicable, remove the mid drive tray.

**WARNING:** Allow the memory modules to cool after you power off the system. Handle the memory modules by the card edges and avoid touching the components or metallic contacts on the memory module.

**CAUTION:** To ensure proper system cooling in configurations with mid drive tray, memory module blanks must be installed in any memory socket that is not occupied. Remove memory module blanks only if you intend to install memory modules in those sockets.

**NOTE:** You must follow the thermal restriction while using DIMM blank. For information about thermal restriction, see the [Thermal restrictions](#) section.

### Steps

- 1 Locate the appropriate memory module socket.

**CAUTION:** Handle each memory module only by the card edges, ensuring not to touch the middle of the memory module or metallic contacts.

- 2 Push the ejectors outward on both ends of the memory module socket to release the memory module from the socket.
- 3 Lift and remove the memory module from the system.

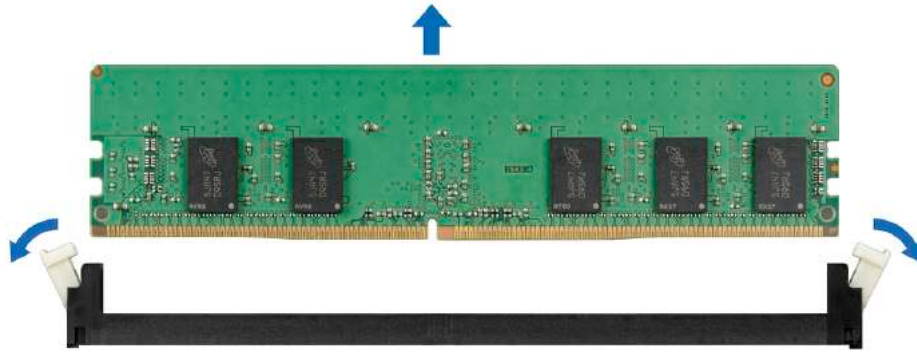

Figure 60. Removing a memory module

#### Next steps

- 1 Install the memory module.
- 2 For configurations with mid drive tray, if you are removing the memory module permanently, install a memory module blank. The procedure to install a memory module blank is similar to that of the memory module.

**NOTE:** For single processor systems, install processor/DIMM blank on CPU2 socket.

**NOTE:** To ensure proper cooling, DIMM blank must be installed for systems with mid drive tray configuration.

#### Related link

[Removing the air shroud](#)

[Installing a memory module](#)

## Installing a memory module

The procedure for installing a memory module and NVDIMM-N is identical.

#### Prerequisites

Follow the safety guidelines listed in [Safety instructions](#).

**CAUTION:** Ensure that you install the NVDIMM-N battery if you are using NVDIMM-N.

**CAUTION:** To prevent data loss and potential damage to your system, ensure that your system, LEDs on system, LEDs on NVDIMM-N and LEDs on NVDIMM-N battery are turned off before installing the NVDIMM-N battery.

**CAUTION:** To ensure proper system cooling in configurations with mid drive tray, memory module blanks must be installed in any memory socket that is not occupied. Remove memory module blanks only if you intend to install memory modules in those sockets.

**NOTE:** You must follow the thermal restriction while using DIMM blank. For information about thermal restriction, see the [Thermal restrictions](#) section.

#### Steps

- 1 Locate the appropriate memory module socket.

**CAUTION:** Handle each memory module only by the card edges, ensuring not to touch the middle of the memory module or metallic contacts.

**CAUTION:** To prevent damage to the memory module or the memory module socket during installation, do not bend or flex the memory module. You must insert both ends of the memory module simultaneously.

- 2 Open the ejectors on the memory module socket outward to allow the memory module to be inserted into the socket.
- 3 Align the edge connector of the memory module with the alignment key of the memory module socket, and insert the memory module in the socket.



**CAUTION:** Do not apply pressure at the center of the memory module; apply pressure at both ends of the memory module evenly.

**NOTE:** The memory module socket has an alignment key that enables you to install the memory module in the socket in only one orientation.

- 4 Press the memory module with your thumbs until the socket levers firmly click into place.

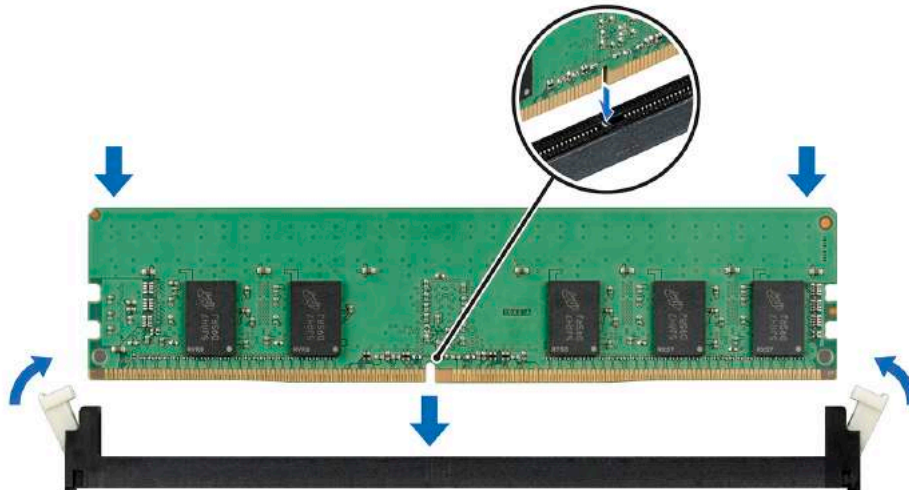

**Figure 61. Installing a memory module**

#### Next steps

- 1 If applicable, install the air shroud.
- 2 If applicable, install the mid drive tray.
- 3 Follow the procedure listed in [After working inside your system](#).
- 4 To verify if the memory module has been installed properly, press F2 and navigate to **System Setup Main Menu > System BIOS > Memory Settings**. In the **Memory Settings** screen, the System Memory Size must reflect the updated capacity of the installed memory.
- 5 If the value is incorrect, one or more of the memory modules may not be installed properly. Ensure that the memory module is firmly seated in the memory module socket.
- 6 Run the system memory test in system diagnostics.

#### Related link

[Installing the air shroud](#)  
[Memory Settings](#)

## Processors and heat sinks

The processor controls memory, peripheral interfaces, and other components of the system. The system can have more than one processor configurations.

The heat sink absorbs the heat generated by the processor, and helps the processor to maintain its optimal temperature level.

# Removing a processor and heat sink module

## Prerequisites

**⚠ WARNING:** The heat sink may be hot to touch for some time after the system has been powered down. Allow the heat sink to cool before removing it.

- 1 Follow the safety guidelines listed in [Safety instructions](#).
- 2 Follow the procedure listed in [Before working inside your system](#).
- 3 If applicable, remove the air shroud.
- 4 If applicable, remove the mid drive tray.
- 5 If applicable, close the PCIe card holder latch on the air shroud to release the full length card.

## Steps

- 1 Using a Torx #T30 screwdriver, loosen the screws on the heat sink in the order below:
  - a Loosen the first screw three turns.
  - b Loosen the second screw completely.
  - c Return to the first screw and loosen it completely.

**ⓘ NOTE:** It is normal for the heat sink to slip off the blue retention clips when the screws are partially loosened, continue to loosen the screw(s).

- 2 Pushing both blue retention clips simultaneously, lift the processor and heat sink module (PHM) out of the system.
- 3 Set the PHM aside with the processor side facing up.

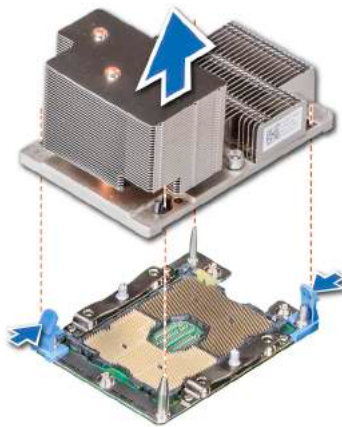
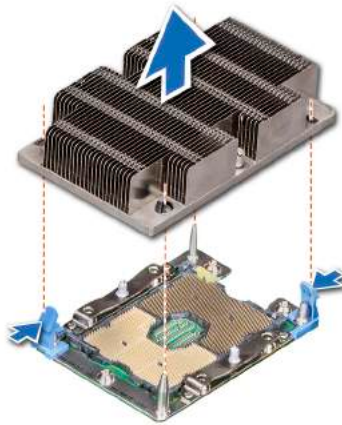

Figure 62. Removing a processor and heat sink module (2U)



**Figure 63. Removing a processor and heat sink module (1U)**

#### Next step

Install the PHM.

#### Related link

[Removing the air shroud](#)

[Opening and closing the PCIe card holder latch](#)

[Installing a processor and heat sink module](#)

## Removing the processor from the processor and heat sink module

#### Prerequisites

**⚠ WARNING:** The heat sink may be hot to touch for some time after the system has been powered down. Allow the heat sink to cool before removing it.

- 1 Follow the safety guidelines listed in [Safety instructions](#).
- 2 Follow the procedure listed in [Before working inside your system](#).
- 3 Remove the processor and heat sink module.

#### Steps

- 1 Place the heat sink with the processor side facing up.
- 2 Insert a flat blade screwdriver into the release slot marked with a yellow label. Twist (do not pry) the screwdriver to break the thermal paste seal.
- 3 Push the retaining clips on the processor bracket to unlock the bracket from the heat sink.

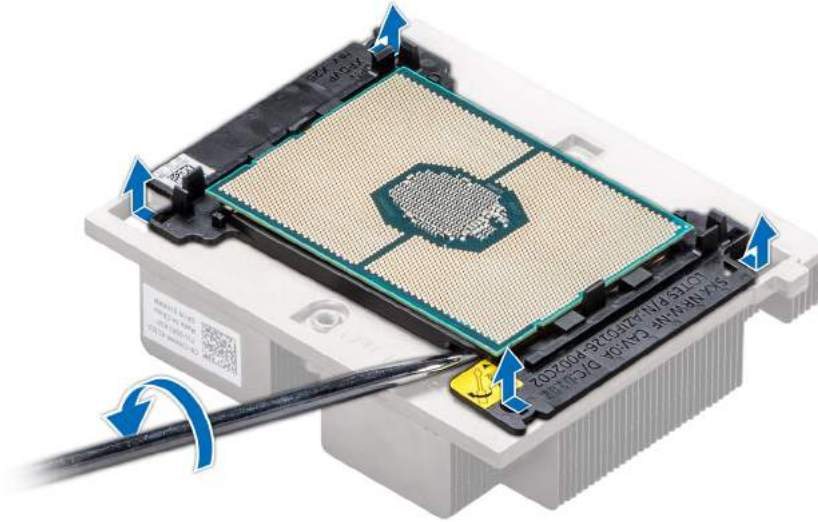

**Figure 64. Loosening the processor bracket**

- 4 Lift the bracket and the processor away from the heat sink, and place the processor connector side down on the processor tray.
- 5 Flex the outer edges of the bracket to release the processor from the bracket.

① **NOTE:** Ensure that the processor and the bracket are placed in the tray after you remove the heat sink.



**Figure 65. Removing the processor bracket**

**Next step**

Install the processor into the processor and heat sink module.

**Related link**

[Removing a processor and heat sink module](#)

[Installing the processor into a processor and heat sink module](#)

# Installing the processor into a processor and heat sink module

## Prerequisite

Follow the safety guidelines listed in [Safety instructions](#).

## Steps

- 1 Place the processor in the processor tray.
  - ① **NOTE:** Ensure that the pin 1 indicator on the processor tray is aligned with the pin 1 indicator on the processor.
- 2 Flex the outer edges of the bracket around the processor ensuring that the processor is locked into the clips on the bracket.
  - ① **NOTE:** Ensure that the pin 1 indicator on the bracket is aligned with the pin 1 indicator on the processor before placing the bracket on the processor.
  - ① **NOTE:** Ensure that the processor and the bracket are placed in the tray before you install the heat sink.



**Figure 66. Installing the processor bracket**

- 3 If you are using an existing heat sink, remove the thermal grease from the heat sink by using a clean lint-free cloth.
- 4 Use the thermal grease syringe included with your processor kit to apply the grease in a quadrilateral design on the top of the processor.
  - ⚠ **CAUTION:** Applying too much thermal grease can result in excess grease coming in contact with and contaminating the processor socket.
  - ① **NOTE:** The thermal grease syringe is intended for single use only. Dispose the syringe after you use it.

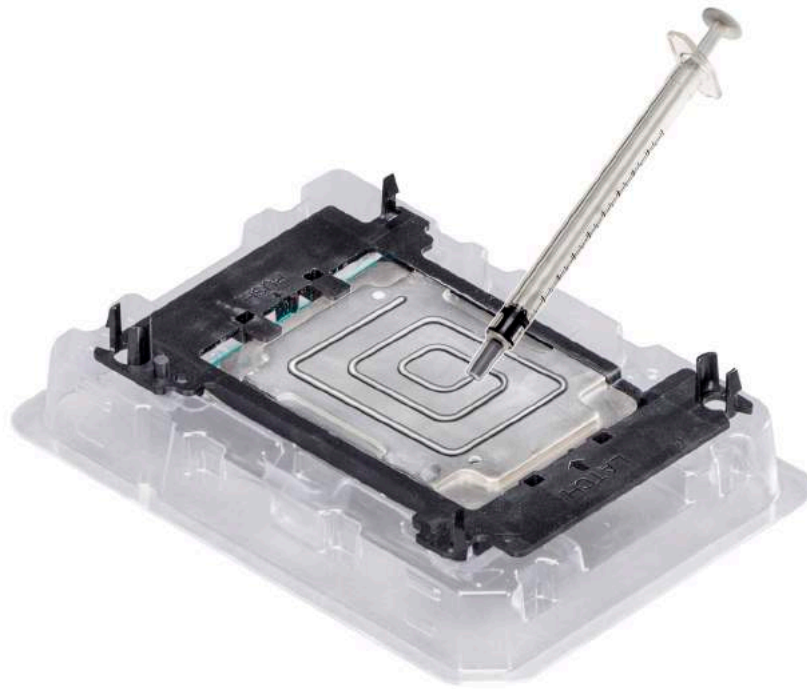
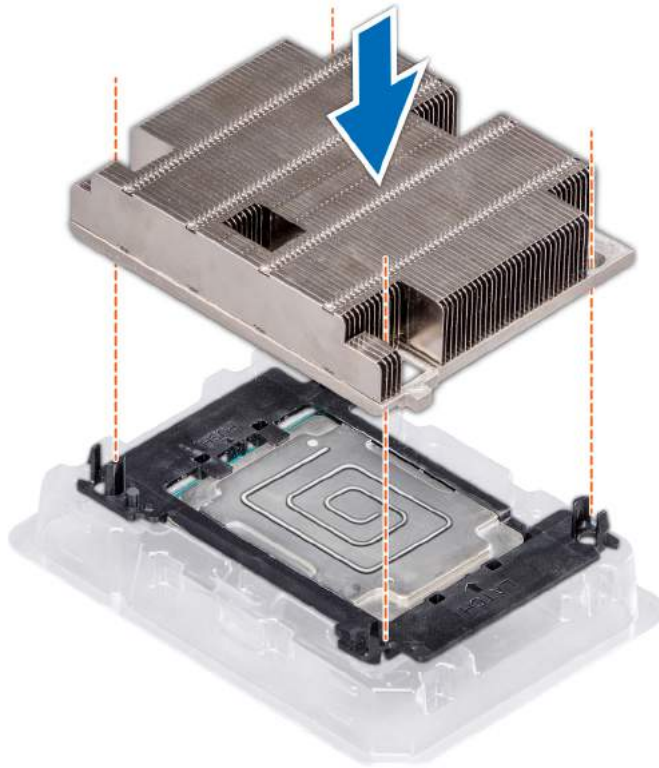

**Figure 67. Applying thermal grease on top of the processor**

- 5 Place the heat sink on the processor and push down until the bracket locks onto the heat sink.

**NOTE:**

- Ensure that the two guide pin holes on the bracket match the guide holes on the heat sink.
- Ensure that the pin 1 indicator on the heat sink is aligned with the pin 1 indicator on the bracket before placing the heat sink onto the processor and bracket.



**Figure 68. Installing the heat sink onto the processor**

#### Next steps

- 1 Install the processor and heat sink module.
- 2 Install the air shroud.
- 3 Follow the procedure listed in [After working inside your system](#).

#### Related link

[Installing a processor and heat sink module](#)

[Installing the air shroud](#)

## Installing a processor and heat sink module

#### Prerequisites

**CAUTION:** Never remove the heat sink from a processor unless you intend to replace the processor. The heat sink is necessary to maintain proper thermal conditions.

- 1 Follow the safety guidelines listed in [Safety instructions](#).
- 2 If installed, remove the processor/DIMM blank and CPU dust cover.  
The procedure to remove the processor/DIMM blank is similar to that of the memory module.

#### Steps

- 1 Align the pin 1 indicator of the heat sink to the system board and then place the processor and heat sink module (PHM) on the processor socket.

**CAUTION:** To avoid damaging the fins on the heat sink, do not press down on the heat sink fins.



**NOTE:** Ensure that the PHM is held parallel to the system board to prevent damaging the components.

- 2 Push the blue retention clips inward to allow the heat sink to drop into place.
- 3 Supporting the heat sink with one hand.
- 4 Using the Torx #T30 screwdriver, tighten the screws on the heat sink in the order below:
  - a Partially tighten the first screw (approximately 3 turns).
  - b Tighten the second screw completely.
  - c Return to the first screw and tighten it completely.

If the PHM slips off the blue retention clips when the screws are partially tightened, follow these steps to secure the PHM:

- a Loosen both the heat sink screws completely.
- b Lower the PHM on to the blue retention clips, follow the procedure described in step 2.
- c Secure the PHM to the system board, follow the procedure described in step 4.

**NOTE:** The processor and heat sink module retention screws should not be tightened to more than 0.13 kgf-m (1.35 N.m or 12 in-lbf).



**Figure 69. Installing the processor and heat sink module (2U)**



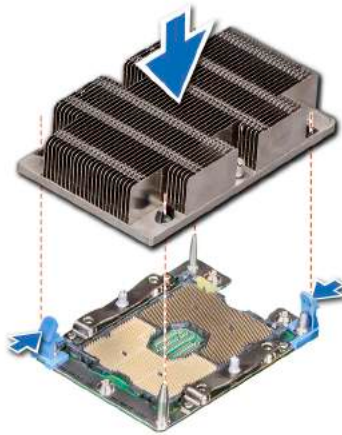

**Figure 70. Installing a processor and heat sink module (1U)**

#### Next steps

- 1 If applicable, install the mid drive tray.
- 2 If applicable, install the air shroud.

**NOTE:** If applicable, open the PCIe card holder latch on the air shroud to install the full length card.

- 3 Follow the procedure listed in [After working inside your system](#).

#### Related link

[Opening and closing the PCIe card holder latch](#)  
[Installing the air shroud](#)

## Expansion cards and expansion card risers

An expansion card in the system is an add-on card that can be inserted into an expansion slot on the system board or riser card to add enhanced functionality to the system through the expansion bus.

**NOTE:** A System Event Log (SEL) event is logged if an expansion card riser is not supported or missing. It does not prevent your system from turning on. However, if F1/F2 pause occurs and an error message is displayed.

## Expansion card installation guidelines

The PowerEdge R740xd system supports up to eight PCI express (PCIe) generation 3 expansion cards, that can be installed on the system board using expansion card risers. The following table provides detailed information about the expansion card riser specifications:

**Table 41. Expansion card riser specifications**

Riser configuration and supported risers	Slot description	PCIe slots on riser 1 (Height and length)	Processor connection	PCIe slots on riser 2 (Height and length)	Processor connection	PCIe slots on riser 3 (Height and length)	Processor connection
Riser configuration 0 with or without rear storage (No riser)	No PCIe slots (only rear storage)	N/A	N/A	N/A	N/A	N/A	N/A
Riser configuration 1 with or without rear storage (1B+2B)	Four x8 slots and rear storage	Slot 1: x8 full-height, full length	Processor 1				
		Slot 2: x8 full-height, full length	Processor 1	Slot 4: x8 low profile, half length	Processor 1	N/A	N/A
		Slot 3: x8 full-height, half length	Processor 1				
Riser configuration 2 with or without rear storage (1B+2C)	Three x8 and one x16 slots and rear storage	Slot 1: x8 full-height, full length	Processor 1				
		Slot 2: x8 full-height, full length	Processor 1	Slot 4: x16 low profile, half length	Processor 2	N/A	N/A
		Slot 3: x8 full-height, half length	Processor 1				
Riser configuration 3 (1A+2A)	Two x8 and three x16 slots	Slot 1: x16 full-height, full length	Processor 1	Slot 4: x16 full-height, full length	Processor 2		
		N/A	N/A	Slot 5: x8 full-height, full length	Processor 2	N/A	N/A
		Slot 3: x16 full-height, half length	Processor 1	Slot 6: x8 low profile, half length	Processor 1		
Riser configuration 4 (1A+2A+3A)	Three x8 and four x16 slots	Slot 1: x16 full-height, full length	Processor 1	Slot 4: x16 full-height, full length	Processor 2	Slot 7: x8 full-height, full length	Processor 2
		N/A	N/A	Slot 5: x8 full-height, full length	Processor 2	Slot 8: x16 full-height, full length	Processor 2
		Slot 3: x16 full-height, half length	Processor 1	Slot 6: x8 low profile, half length	Processor 1		
Riser configuration 5 (1B+2A+3A)	Six x8 and two x16 slots	Slot 1: x8 full-height, full length	Processor 1	Slot 4: x16 full-height, full length	Processor 2	Slot 7: x8 full-height, full length	Processor 2
		Slot 2: x8 full-height, full length	Processor 1	Slot 5: x8 full-height, full length	Processor 2	Slot 8: x16 full-height, full length	Processor 2
		Slot 3: x8 full-height, half length	Processor 1	Slot 6: x8 low profile, half length	Processor 1		
Riser configuration 6 (1D+2A+3A)	Five x8 and three x16 slots	Slot 1: x16 full-height, full length	Processor 1	Slot 4: x16 full-height, full length	Processor 2	Slot 7: x8 full-height, full length	Processor 2
		Slot 2: x8 full-height, full length	Processor 1	Slot 5: x8 full-height, full length	Processor 2	Slot 8: x16 full-height, full length	Processor 2

Riser configuration and supported risers	Slot description	PCIe slots on riser 1 (Height and length)	Processor connection	PCIe slots on riser 2 (Height and length)	Processor connection	PCIe slots on riser 3 (Height and length)	Processor connection
Riser configuration 9 (1A+2D+3A)	Three x8 and four x16 slots	Slot 3: x8 full-height, half length	Processor 1	Slot 6: x8 low profile, half length	Processor 1		
		Slot 1: x16 full-height, full length	Processor 1	Slot 4: x16 full-height, full length	Processor 2	Slot 7: x8 full-height, full length	Processor 2
		N/A	N/A	Slot 5: x8 full-height, full length	Processor 2	Slot 8: x16 full-height, full length	Processor 2
		Slot 3: x16 full-height, half length	Processor 1	Slot 6: x8 low profile, half length	Processor 1		

**Table 42. Riser configurations with 4 PCIe slots [Riser configuration 1 with or without rear storage (1B+2B) and Riser configuration 2 with or without rear storage (1B+2C)]**

Card Type	Slot priority	Maximum number of cards
GPU (double width)	N/A	N/A
GPU (single width)	N/A	N/A
PCIe Bridge	4	1
Internal storage adapter	4	1
Express Flash NVMe PCIe SSD adapter	1, 2, 3, 4	4
HCA EDR	4	1
100 GB NIC	4	1
100 G OPA	4	1
HCA FDR	4	1
40 GB NIC	1, 2, 3	3
40 GB NIC	4	1
HBA FC32	1, 2, 3	3
HBA FC32	4	1
25 GB NIC	1, 2, 3	3
25 GB NIC	4	1
HBA FC16	1, 2, 3	3
HBA FC16	4	1
10 GB NIC	1, 2, 3	3
10 GB NIC	4	1
HBA FC8	1, 2, 3	3
HBA FC8	4	1
1 GB NIC	1, 2, 3	3
1 GB NIC	4	1
External storage adapter	1, 2, 3	3

Card Type	Slot priority	Maximum number of cards
External storage adapter	4	1
BOSS	1, 2, 3	1
BOSS	4	1

**Table 43. Riser configurations with greater than 4 PCIe slots [Riser configuration 3 (1A+2A), Riser configuration 4 (1A+2A+3A), Riser configuration 5 (1B+2A+3A), Riser configuration 6 (1D+2A+3A) and Riser configuration 9 (1A+2D+3A)]**

Card Type	Slot priority	Maximum number of cards
GPU (double width)	1, 8, 4	3
GPU (single width)	1, 8, 4, 7, 2, 5	6
PCIe Bridge	1, 3, 4, 8	3
Internal storage adapter	6, 5	1
Express Flash NVMe PCIe SSD adapter	7, 2, 3, 5, 1, 8, 4, 6	6
HCA EDR	1, 8, 4	3
100 GB NIC	1, 8, 4	3
100 G OPA	1, 8, 4	3
HCA FDR	6	1
40 GB NIC	7, 2, 3, 5, 1, 8, 4	7
40 GB NIC	6	1
HBA FC32	7, 2, 3, 5, 1, 8, 4	7
HBA FC32	6	1
25 GB NIC	7, 2, 3, 5, 1, 8, 4	3
25 GB NIC	6	1
HBA FC16	7, 2, 3, 5, 1, 8, 4	7
HBA FC16	6	1
10 GB NIC	7, 2, 3, 5, 1, 8, 4	7
10 GB NIC	6	1
HBA FC8	7, 2, 3, 5, 1, 8, 4	7
HBA FC8	6	1
1 GB NIC	7, 2, 3, 5, 1, 8, 4	7
1 GB NIC	6	1
External storage adapter	7, 2, 3, 5, 1, 8, 4	7
External storage adapter	6	1
BOSS	7, 2, 3, 5, 1, 8, 4	1
BOSS	6	1
Internal storage	7, 2, 3, 5, 1, 8, 4, 6	6

- ① **NOTE:** For information about slot form factor, see the Expansion card riser configurations table.
- ① **NOTE:** The expansion card slots are not hot-swappable.
- ① **NOTE:** Double width GPUs are supported only on riser configuration 4, and single width GPUs are supported only on riser configuration 6.
- ① **NOTE:** Ensure that x16 cards are installed only in x16 slots. Depending on the riser configuration slots 2, 7, or 8 may not be available.
- ① **NOTE:** Only half length PCIe cards are supported on riser 2 when NVDIMM-Ns with NVDIMM-N battery are installed on the air shroud.
- ① **NOTE:** For 24x2.5 inch 24 NVMe drive configuration, the PCIe bridge cards must be installed in slots 3 and 4.

## Opening and closing the PCIe card holder latch

Before installing or removing a full length PCIe card, the PCIe card holder latch must be closed. When the full length PCIe card is installed, open the PCIe card holder latch.

### Prerequisites

- 1 Follow the safety guidelines listed in [Safety instructions](#).
- 2 Follow the procedure listed in [Before working inside your system](#).

### Steps

- 1 To open the PCIe card holder latch, press the release tab.



**Figure 71. Opening the PCIe card holder latch**

- 2 To close the PCIe card holder latch, push the latch until it locks.



**Figure 72. Closing the PCIe card holder latch**

**Next step**

Follow the procedure listed in [After working inside your system](#).

## Removing the expansion card from expansion card riser

**Prerequisites**

- 1 Follow the safety guidelines listed in [Safety instructions](#).
- 2 Follow the procedure listed in [Before working inside your system](#).
- 3 If applicable, remove the air shroud.
- 4 If applicable, disconnect the cables from the expansion card.
- 5 When removing a card from riser 2 or 3, ensure that the PCIe card holder latch is closed.

**Steps**

- 1 Pull the expansion card latch out of the slot.
- 2 Hold the expansion card by its edges, and pull the card until the card edge connector disengages from the expansion card connector on the riser.

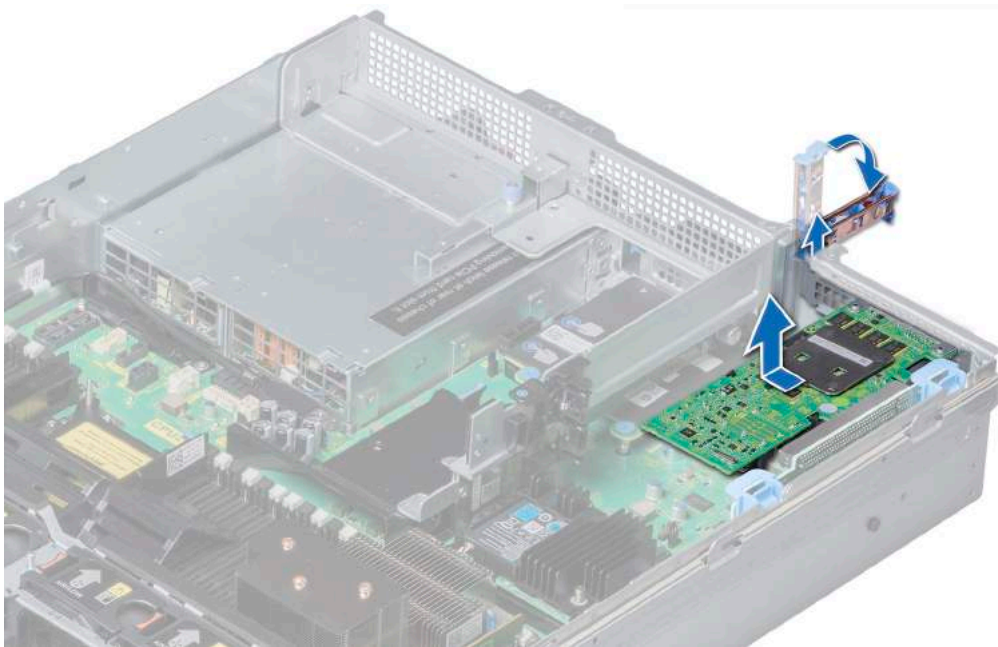

Figure 73. Removing the expansion card from expansion card riser 1

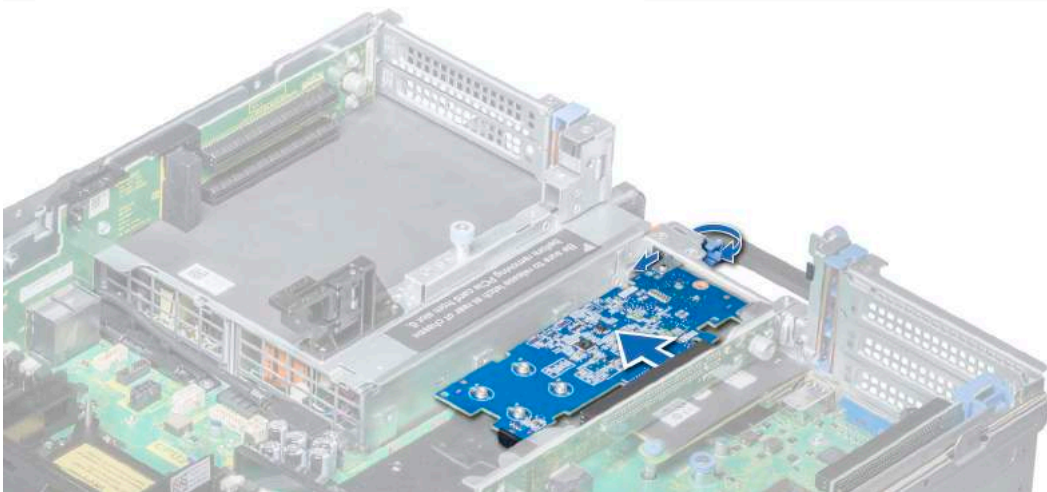

Figure 74. Removing the expansion card from expansion card riser 2B



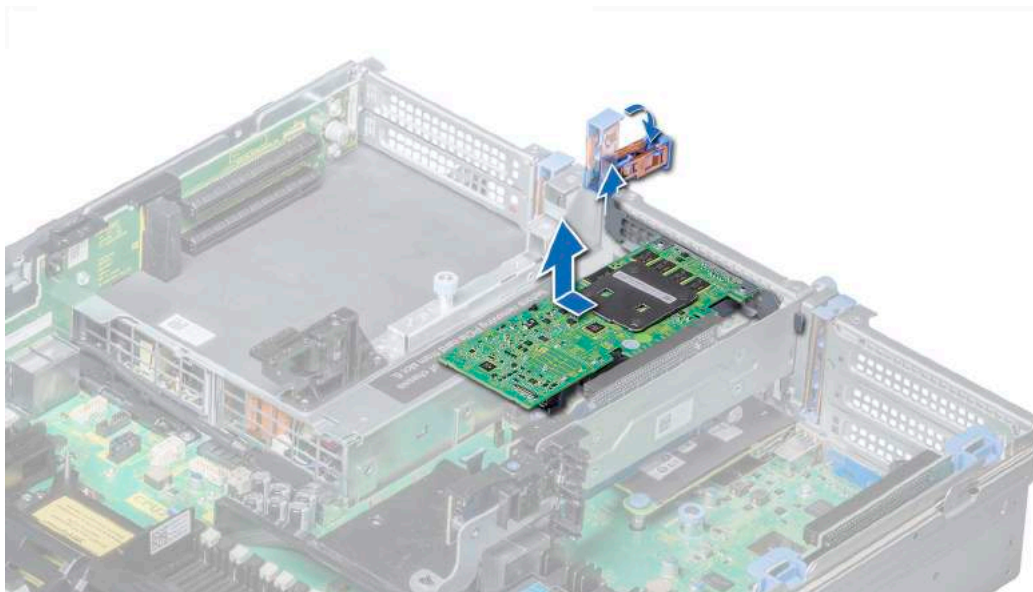

Figure 75. Removing the expansion card from expansion card riser 2

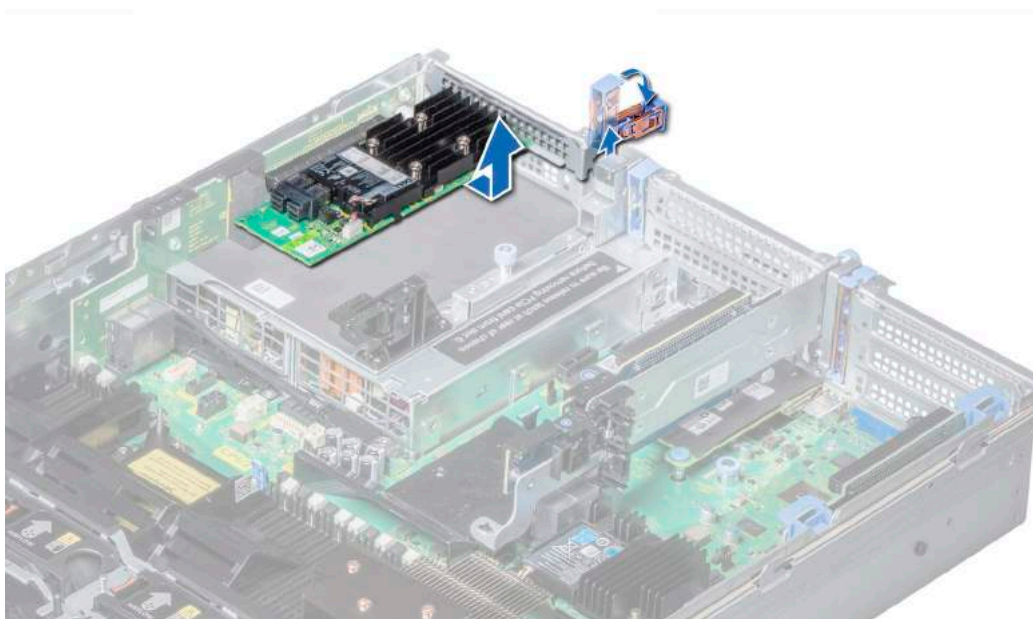

Figure 76. Removing the expansion card from expansion card riser 3

#### Next steps

- 1 Install the expansion card into expansion card riser.
- 2 If you are removing the card permanently, install a metal filler bracket over the empty expansion slot opening and push the expansion card latch.

**NOTE:** You must install a filler bracket over an empty expansion card slot to maintain Federal Communications Commission (FCC) certification of the system. The brackets also keep dust and dirt out of the system and aid in proper cooling and airflow inside the system.



## Related link

[Removing the air shroud](#)

[Opening and closing the PCIe card holder latch](#)

[Installing expansion card into expansion card riser](#)

# Installing expansion card into expansion card riser

## Prerequisites

- 1 Follow the safety guidelines listed in [Safety instructions](#).
- 2 If installing a new expansion card, unpack it and prepare the card for installation.

**NOTE:** For instructions, see the documentation accompanying the card.

- 3 When installing a card into riser 2 or 3, open the PCIe card holder latch.

## Steps

- 1 Pull the expansion card latch.
- 2 If installed, remove the filler bracket.

**NOTE:** Store the filler bracket for future use. Filler brackets must be installed in empty expansion card slots to maintain Federal Communications Commission (FCC) certification of the system. The brackets also keep dust and dirt out of the system and aid in proper cooling and airflow inside the system.

- 3 Hold the card by its edges, and align the card edge connector with the expansion card connector on the riser.
- 4 Insert the card edge connector firmly into the expansion card connector until the card is fully seated.
- 5 Push the expansion card latch.

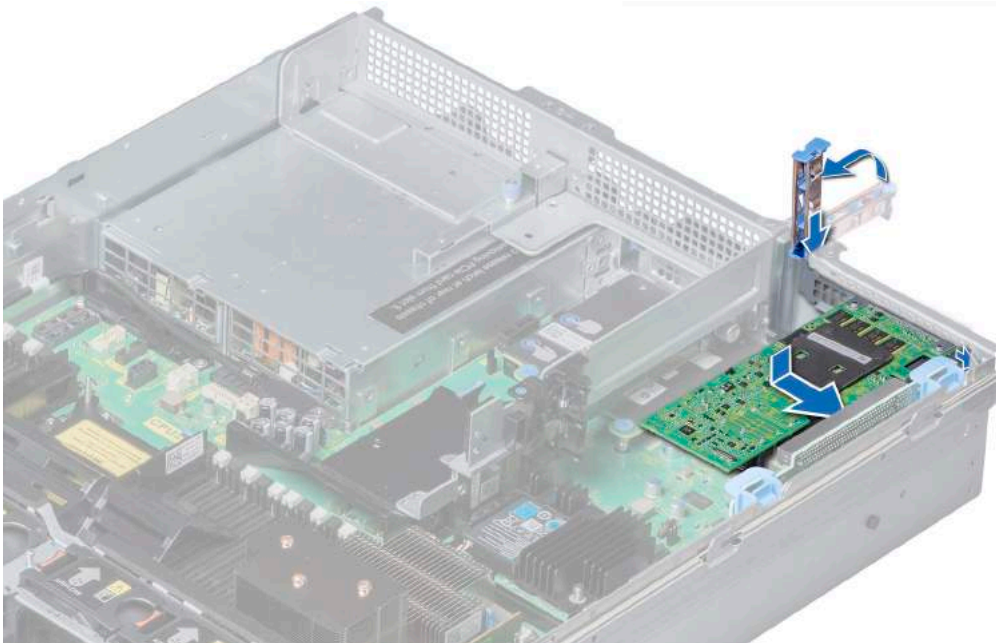

Figure 77. Installing expansion card into expansion card riser 1

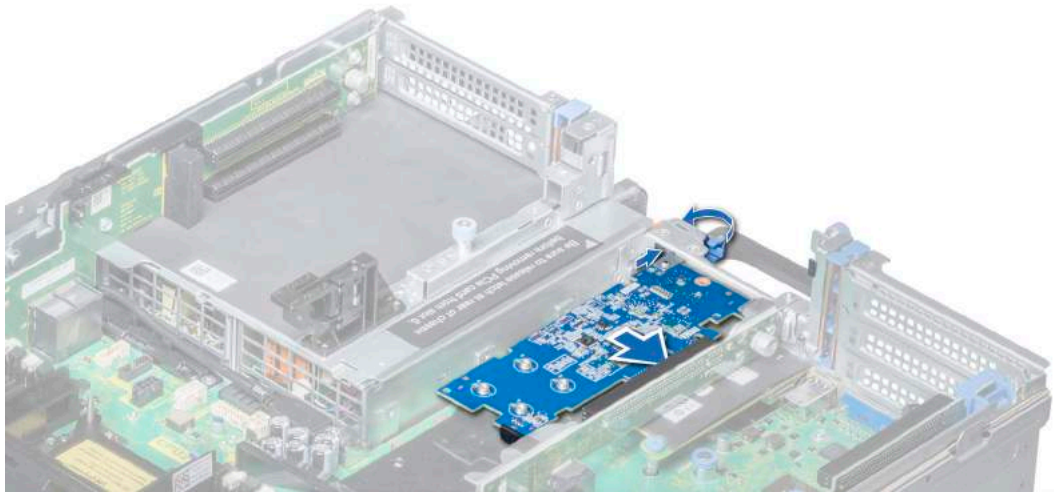

Figure 78. Installing expansion card into expansion card riser 2B

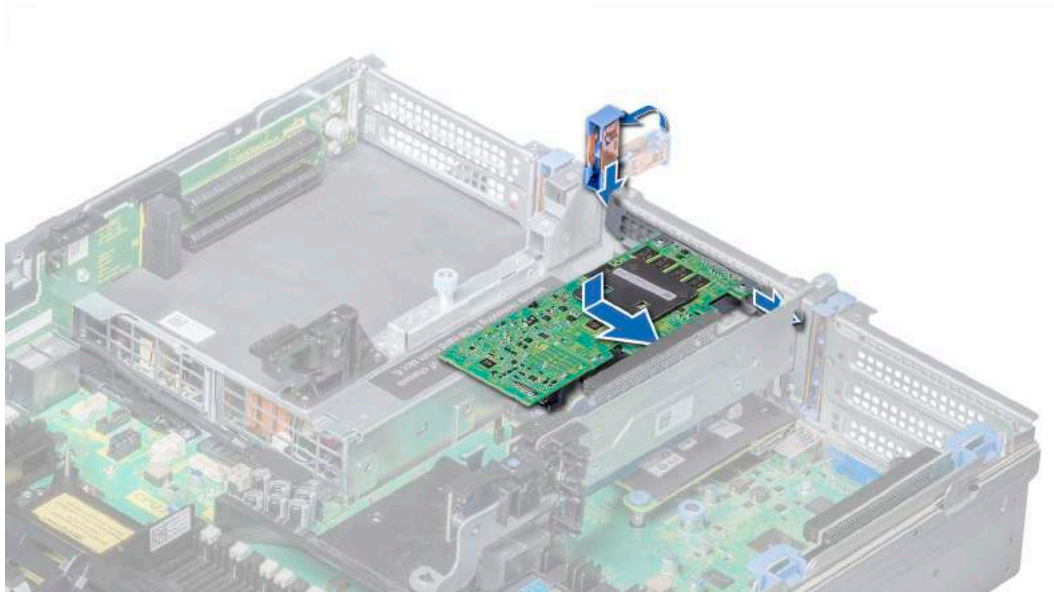
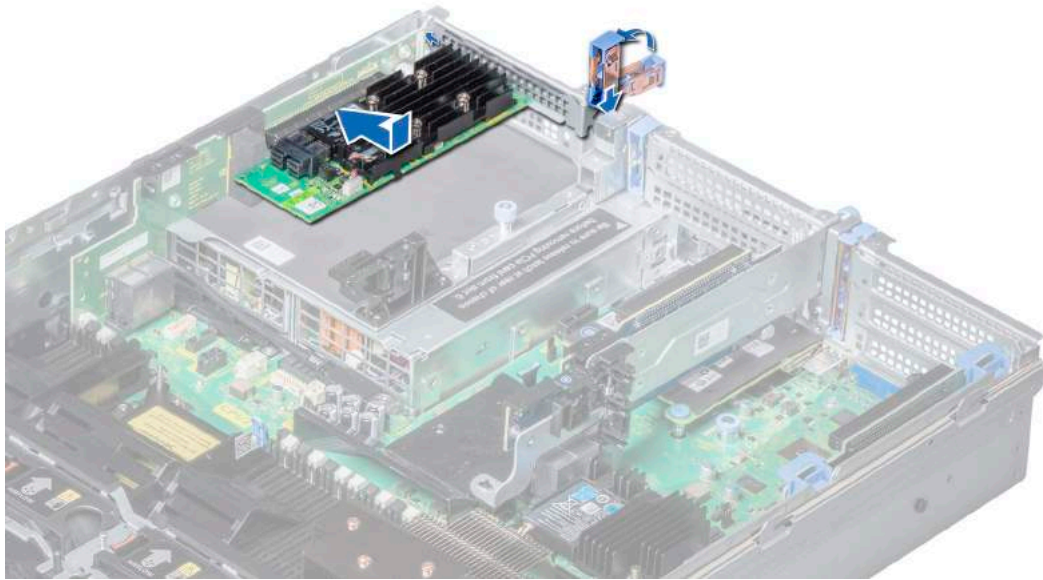

Figure 79. Installing expansion card into expansion card riser 2



**Figure 80. Installing expansion card into expansion card riser 3**

#### **Next steps**

- 1 If applicable, connect the cables to the expansion card.
- 2 If applicable, install the air shroud.
- 3 Follow the procedure listed in [After working inside your system](#).
- 4 Install any device drivers required for the card as described in the documentation for the card.

#### **Related link**

- [Opening and closing the PCIe card holder latch](#)
- [Installing the air shroud](#)

## Removing riser 2 and 3 blank

#### **Prerequisites**

- 1 Follow the safety guidelines listed in [Safety instructions](#).
- 2 Follow the procedure listed in [Before working inside your system](#).
- 3 Remove the air shroud.

#### **Steps**

- 1 Using Phillips #2 screwdriver, loosen the screws (3) that secure the blank to the system.
- 2 Press the release tab, and holding the blank by its edges, lift the blank away from the system.

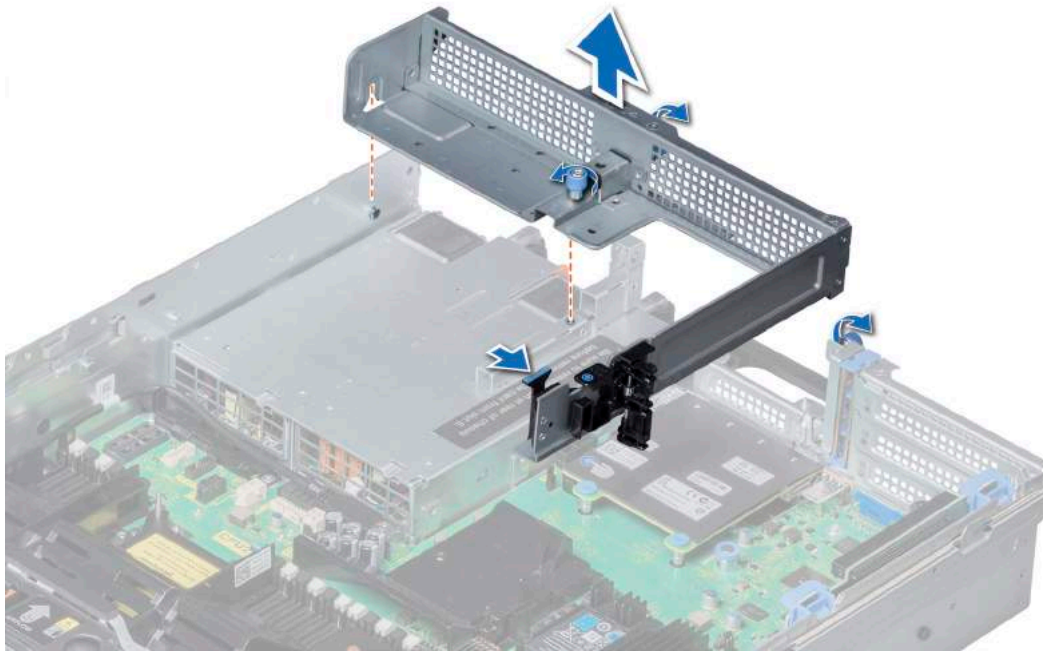

**Figure 81. Removing riser 2 and 3 blank**

**Next step**

Install the riser 2 and 3 blank.

**Related link**

[Removing the air shroud](#)

[Installing riser 2 and 3 blank](#)

## Installing riser 2 and 3 blank

**Prerequisite**

Follow the safety guidelines listed in [Safety instructions](#).

**Steps**

- 1 Align the screw and guide rail on the riser blank with the screw hole and standoff on the system.
- 2 Lower the blank into the system until the release tab clicks into place.
- 3 Tighten the screws to secure the riser blank to the system.



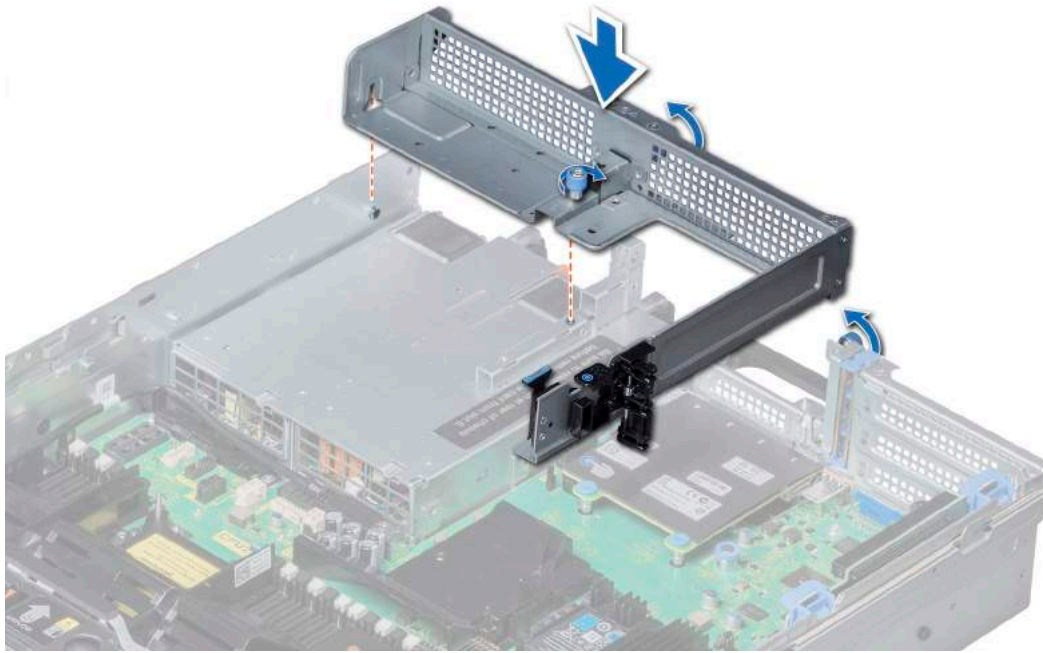

**Figure 82. Installing riser 2 and 3 blank**

#### **Next steps**

- 1 Install the air shroud.
- 2 Follow the procedure listed in [After working inside your system](#).

#### **Related link**

[Installing the air shroud](#)

## Removing riser 3 blank

#### **Prerequisites**

- 1 Follow the safety guidelines listed in [Safety instructions](#).
- 2 Follow the procedure listed in [Before working inside your system](#).

#### **Steps**

- 1 Using Phillips #2 screwdriver, loosen the screw that secures the blank to the system.
- 2 Lift the blank away from the system.

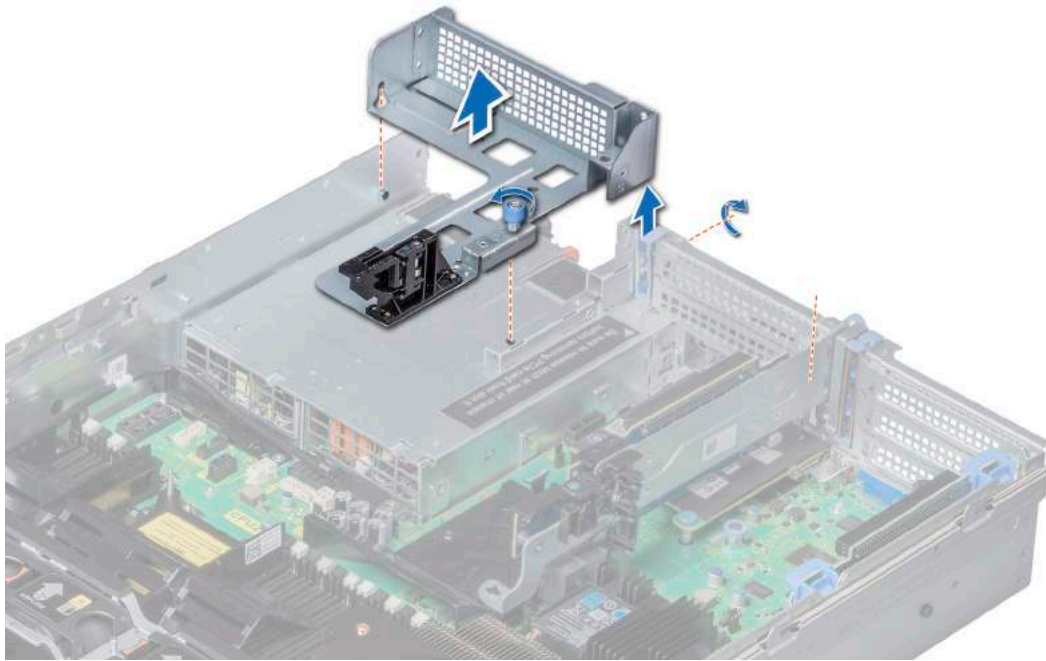

**Figure 83. Removing riser 3 blank**

**Next step**

Install the riser 3 blank.

**Related link**

[Installing riser 3 blank](#)

## Installing riser 3 blank

**Prerequisite**

Follow the safety guidelines listed in [Safety instructions](#).

**Steps**

- 1 Align the screw on the riser with the screw hole on the system.
- 2 Using Phillips #2 screwdriver, tighten the screw to secure the blank to the system.

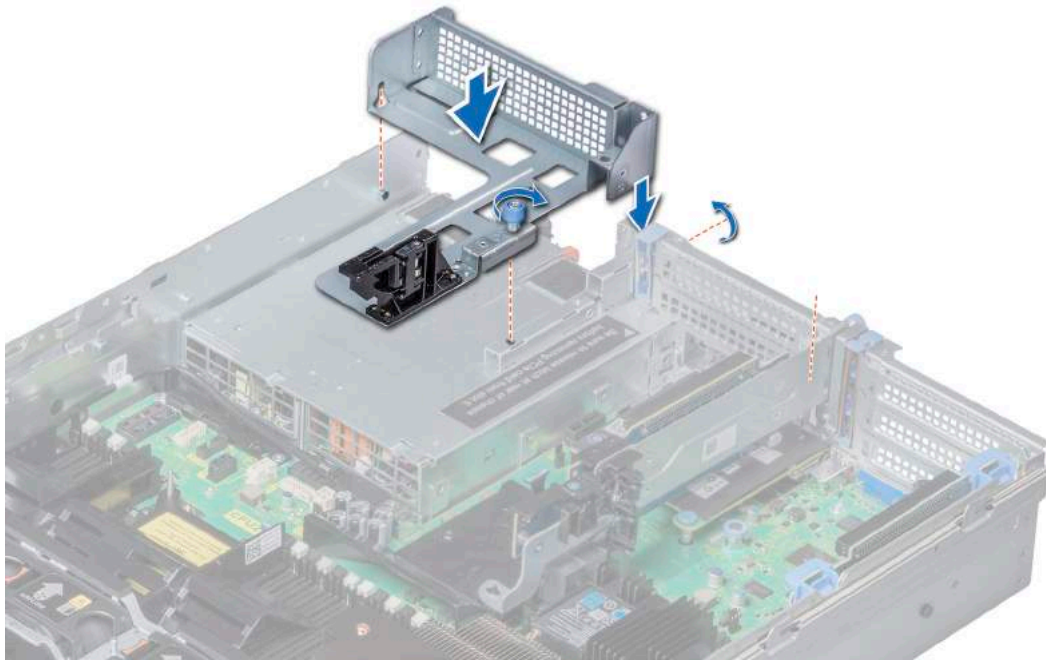

**Figure 84. Installing riser 3 blank**

**Next step**

Follow the procedure listed in [After working inside your system](#).

## Removing expansion card riser 1

**Prerequisites**

- 1 Follow the safety guidelines listed in [Safety instructions](#).
- 2 Follow the procedure listed in [Before working inside your system](#).
- 3 If installed, remove the expansion cards from the riser.
- 4 Disconnect any cables connected to the riser.

**Step**

Press the release latches, and lift the riser from the riser connector on the system board.

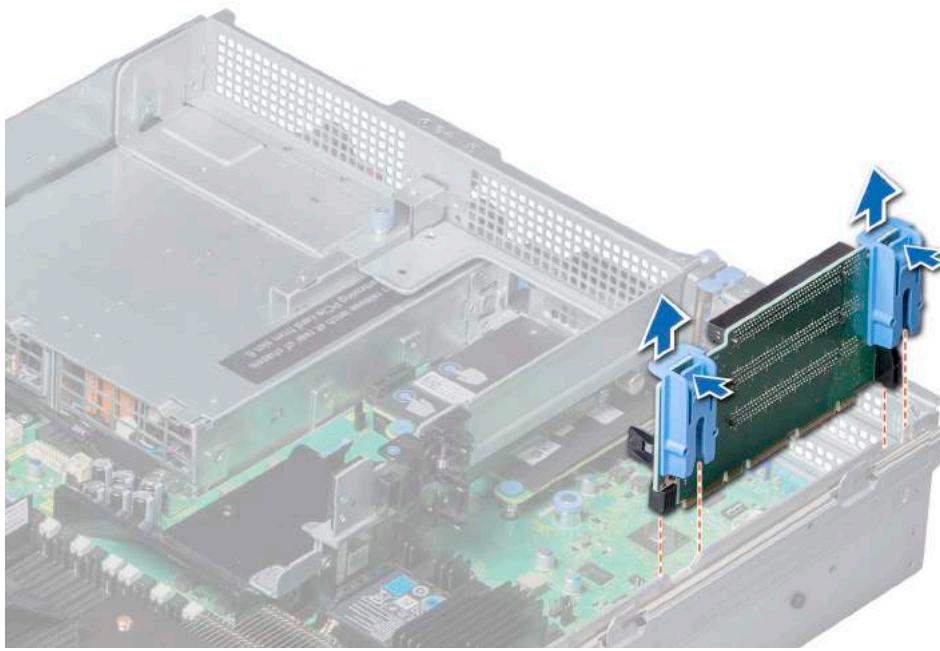

**Figure 85. Removing expansion card riser 1**

**Next step**

Install the expansion card riser 1.

**Related link**

[Removing the expansion card from expansion card riser](#)

[Installing expansion card riser 1](#)

## Installing expansion card riser 1

**Prerequisite**

Follow the safety guidelines listed in [Safety instructions](#).

**Steps**

- 1 Align the guide rails on the riser with the standoffs on the side of the system.
- 2 Lower the riser into the system until the riser connector engages with the connector on the system board.



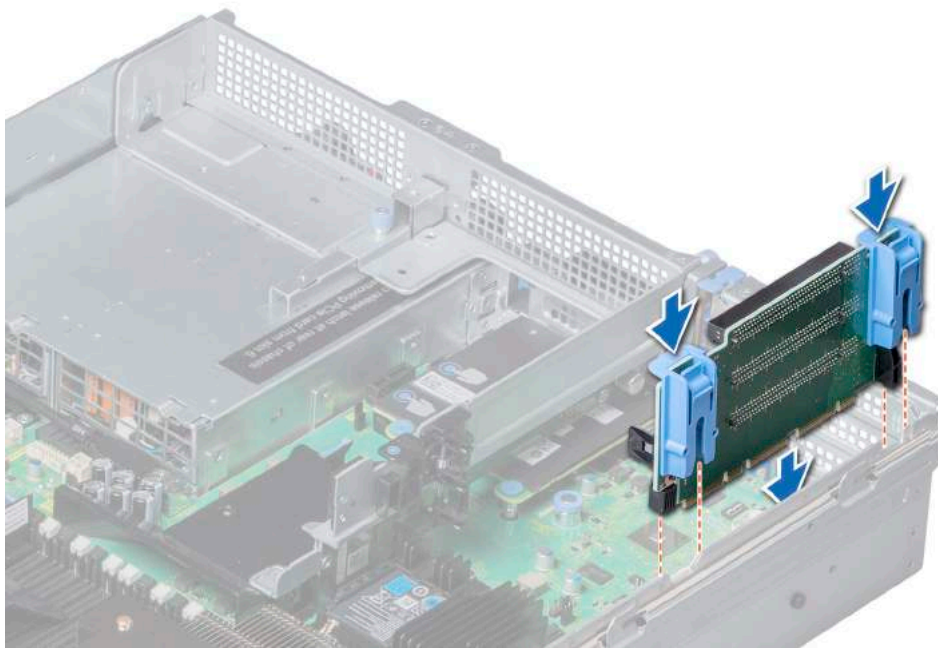

**Figure 86. Installing expansion card riser 1**

#### Next steps

- 1 If removed, install expansion cards into the riser.
- 2 Follow the procedure listed in [After working inside your system](#).
- 3 Install any device drivers required for the card as described in the documentation for the card.

#### Related link

[Installing expansion card into expansion card riser](#)

## Removing expansion card riser 2

#### Prerequisites

- 1 Follow the safety guidelines listed in [Safety instructions](#).
- 2 Follow the procedure listed in [Before working inside your system](#).
- 3 If applicable, close the PCIe card holder latch on the air shroud to release the full length card.
- 4 If installed, remove expansion cards installed on the riser.
- 5 Remove the air shroud.
- 6 Disconnect any cables connected to the riser.

#### Steps

- 1 To remove expansion card riser 2A:
  - a Using Phillips #2 screwdriver, loosen the screws that secure the riser to the system.
  - b Press the release tab, and holding the riser by its edges, lift the riser from the riser connector on the system board.

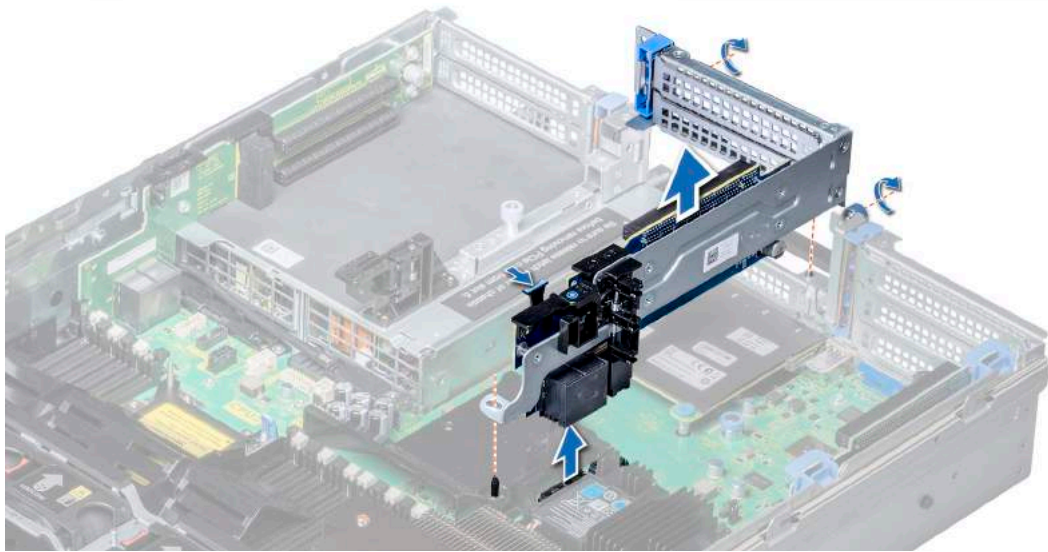

**Figure 87. Removing expansion card riser 2A**

- 2 To remove expansion card riser 2B or 2C, hold the riser by its edges and lift the riser from the riser connector on the system board.

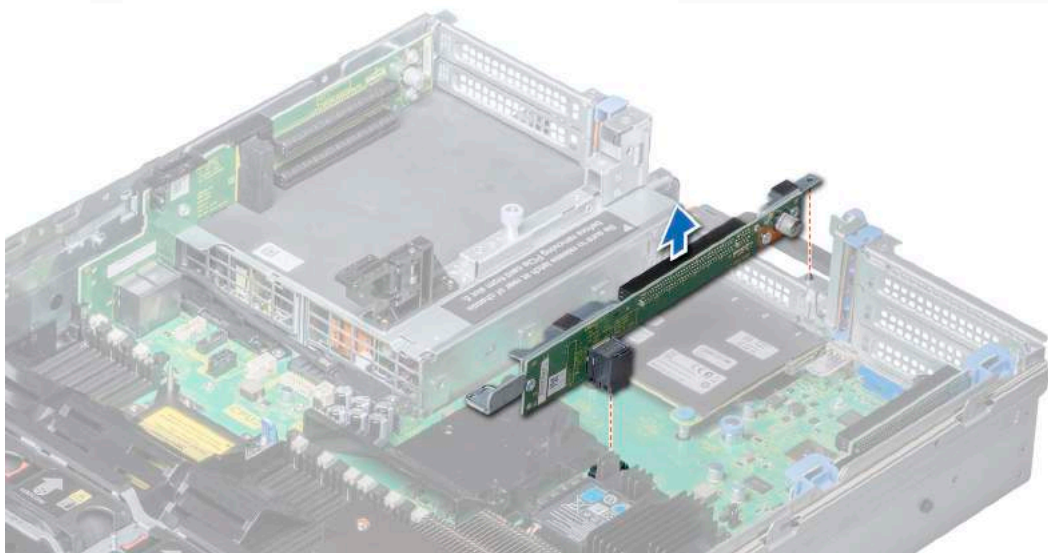

**Figure 88. Removing expansion card riser 2**

**Next step**

Install the expansion card riser 2.

**Related link**

[Removing the expansion card from expansion card riser](#)

[Removing the air shroud](#)

[Installing expansion card riser 2](#)

## Installing expansion card riser 2

**Prerequisite**

Follow the safety guidelines listed in [Safety instructions](#).

## Steps

- 1 To install expansion card riser 2A:
  - a Align the screw and tab on the riser with the screw hole and slot on the system.
  - b Lower the riser into the system until the riser connector engages with the connector on the system board.
  - c Using Phillips #2 screwdriver, tighten the screws to secure the riser to the system.

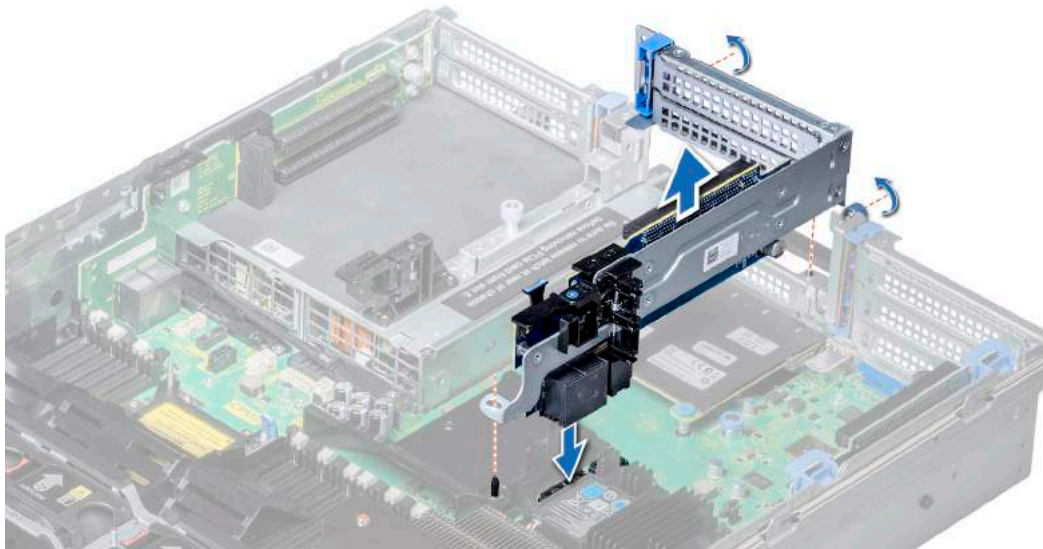

**Figure 89. Installing expansion card riser 2A**

- 2 To install expansion card riser 2B or 2C:
  - a Align the slot on the riser with the standoff on the system.
  - b Lower the riser into the system until the riser card connector engages with the connector on the system board.

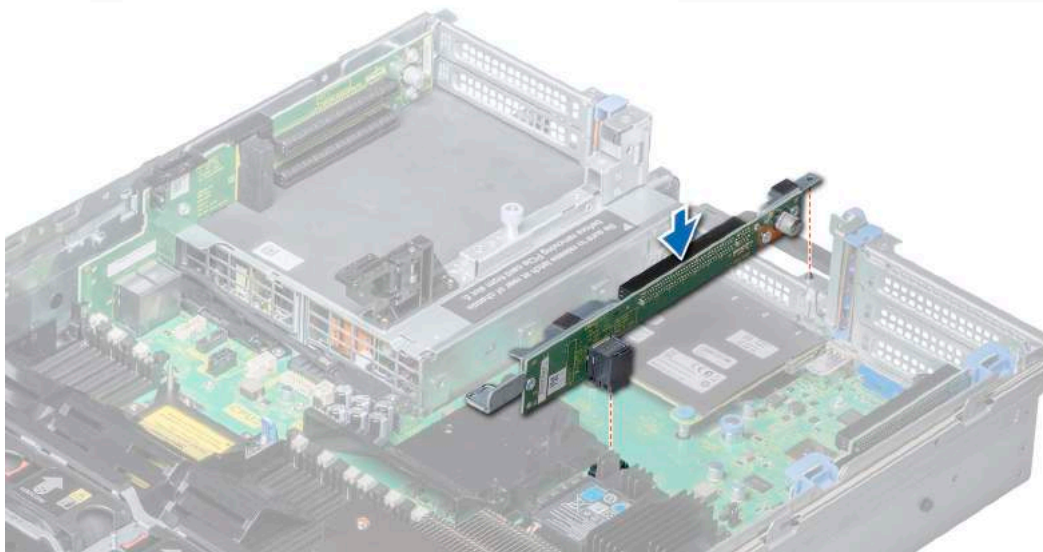

**Figure 90. Installing expansion card riser 2**

## Next steps

- 1 Install the air shroud.
- 2 If removed, install the expansion cards into the riser.



- 3 If applicable, open the PCIe card holder latch on the air shroud to install the full length card.
- 4 Follow the procedure listed in [After working inside your system](#).
- 5 Install any device drivers required for the card as described in the documentation for the card.

**Related link**

- [Installing the air shroud](#)
- [Installing expansion card into expansion card riser](#)

## Removing expansion card riser 3

**Prerequisites**

- 1 Follow the safety guidelines listed in [Safety instructions](#).
- 2 Follow the procedure listed in [Before working inside your system](#).
- 3 Remove the air shroud.

**NOTE:** If applicable, close the PCIe card holder latch on the air shroud to release the full length card.

- 4 If installed, remove expansion cards installed on the riser.
- 5 Disconnect any cables connected to the riser card.

**Steps**

- 1 Using Phillips #2 screwdriver, loosen the screw that secures the riser to the system.
- 2 Press the release tab, and holding the riser by its edges, lift the riser from the riser connector on the system board.

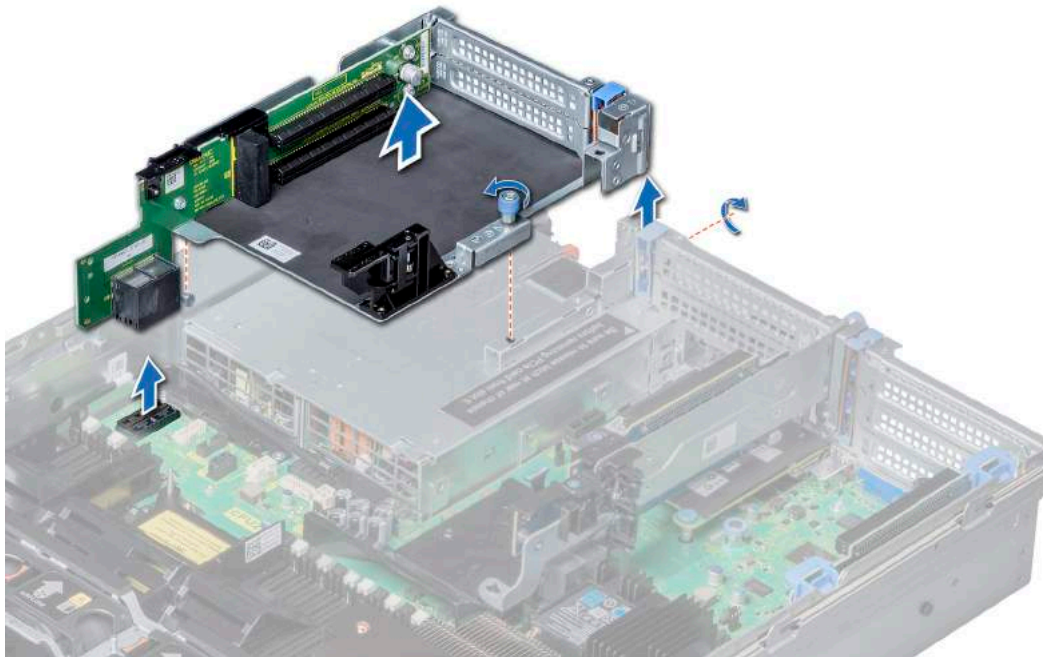

**Figure 91. Removing expansion card riser 3**

**Next step**

Install the expansion card riser 3.

**Related link**

- [Installing expansion card riser 3](#)

# Installing expansion card riser 3

## Prerequisite

Follow the safety guidelines listed in [Safety instructions](#).

## Steps

- 1 Align the tab on the riser with the slot on the system, and guide rails on the riser with the standoffs on the side of the system.
- 2 Lower the riser into the system until the riser edge connector engages with the connector on the system board.  
The riser card edge engages with the riser guide on the system.
- 3 Using Phillips #2 screwdriver, tighten the screw to secure the riser to the system.

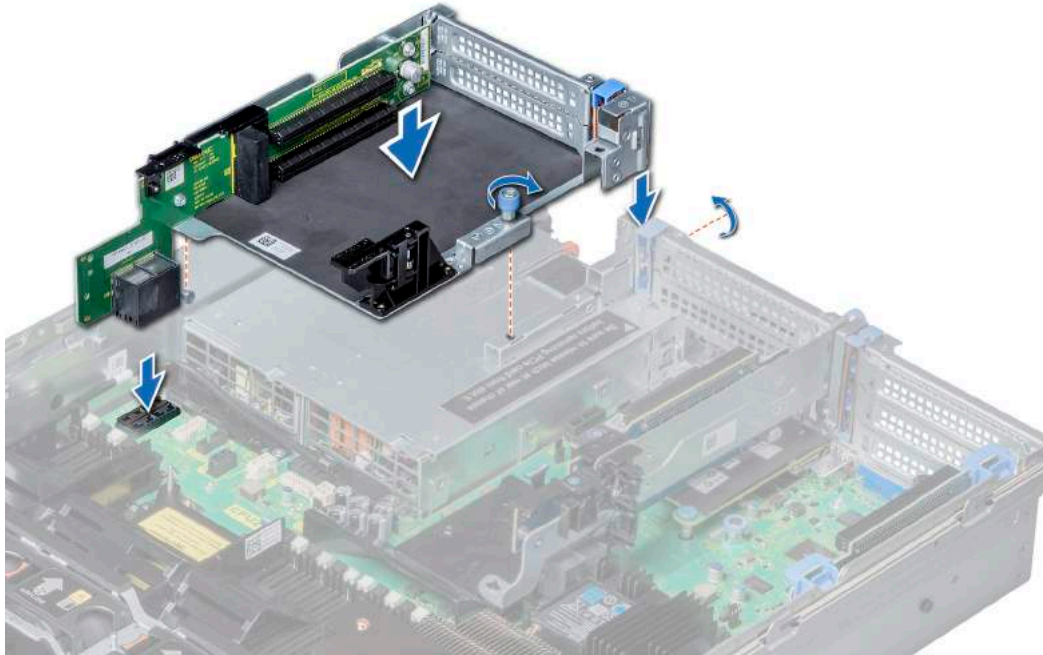

Figure 92. Installing expansion card riser 3

## Next steps

- 1 If removed, install expansion cards into the riser.
- 2 Install the air shroud.  
**NOTE:** If applicable, open the PCIe card holder latch on the air shroud to install the full length card.
- 3 Follow the procedure listed in [After working inside your system](#).
- 4 Install any device drivers required for the card as described in the documentation for the card.

## Related link

[Installing expansion card into expansion card riser](#)

[Installing the air shroud](#)

# IDSDM/vFlash card (optional)

The IDSDM/vFlash card combines the IDSDM and/or vFlash features into a single module.

# Removing the micro SD card

## Prerequisites

- 1 Follow the safety guidelines listed in [Safety instructions](#).
- 2 Follow the procedure listed in [Before working inside your system](#).

## Steps

- 1 Locate the SD card slot on the vFlash/IDSDM module, and press the card to partially release it from the slot.
- 2 Hold the SD card and remove it from the slot.

**NOTE:** Temporarily label each SD card with its corresponding slot number after removal.

## Next step

Install a micro SD card.

## Related link

[Installing the micro SD card](#)

# Installing the micro SD card

## Prerequisites

Follow the safety guidelines listed in [Safety instructions](#).

**NOTE:** To use an SD card with your system, ensure that the Internal SD Card Port is enabled in System Setup.

**NOTE:** Re-install the micro SD cards into the same slots based on the labels you had marked on the cards during removal.

## Steps

- 1 Locate the SD card connector on the internal dual SD module. Orient the SD card appropriately and insert the contact-pin end of the card into the slot.

**NOTE:** The slot is keyed to ensure correct insertion of the card.

- 2 Press the card into the card slot to lock it into place.

## Next step

Follow the procedure listed in [After working inside your system](#).

# Removing the optional IDSDM or vFlash card

## Prerequisites

- 1 Follow the safety guidelines listed in [Safety instructions](#).
- 2 Follow the procedure listed in [Before working inside your system](#).
- 3 If applicable, remove the rear drive cage.
- 4 If applicable, remove the full-height PCIe card.
- 5 If you are replacing the IDSDM/vFlash card, remove the MicroSD cards.

**NOTE:** Temporarily label each MicroSD card with its corresponding slot number after removal.

## Steps

- 1 Locate the IDSDM/vFlash connector on the system board.

To locate IDSDM/vFlash, see the System board jumpers and connectors section.

- 2 Holding the pull tab, lift the IDSDM/vFlash card out of the system.

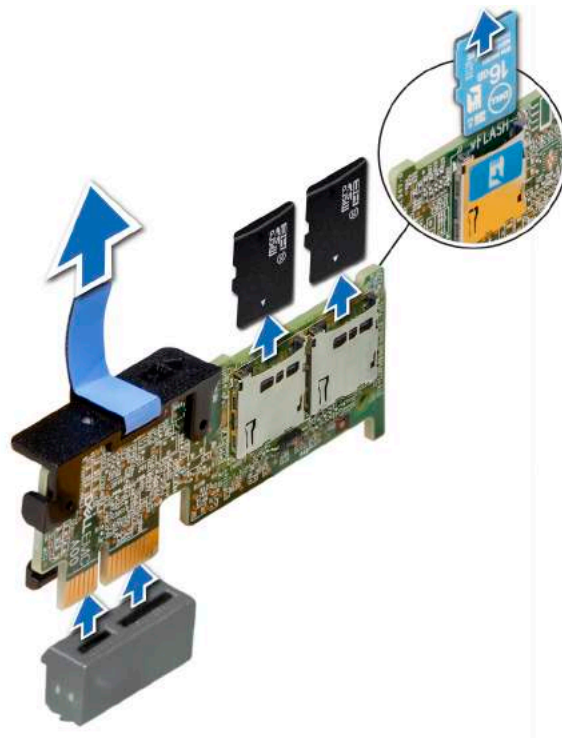

**Figure 93. Removing the optional IDSDM/vFlash card**

**NOTE:** There are two dip switches on the IDSDM/vFlash card for write-protection.

#### Next step

Install the optional IDSDM/vFlash card.

#### Related link

[Removing the expansion card from expansion card riser](#)

[Removing the micro SD card](#)

[Installing optional IDSDM or vFlash card](#)

## Installing optional IDSDM or vFlash card

#### Prerequisite

Follow the safety guidelines listed in [Safety instructions](#).

#### Steps

- 1 Locate the IDSDM/vFlash connector on the system board.  
To locate IDSDM/vFlash, see the System board jumpers and connectors section.
- 2 Align IDSDM/vFlash card with the connector on the system board.
- 3 Push IDSDM/vFlash card until it is firmly seated on the system board.



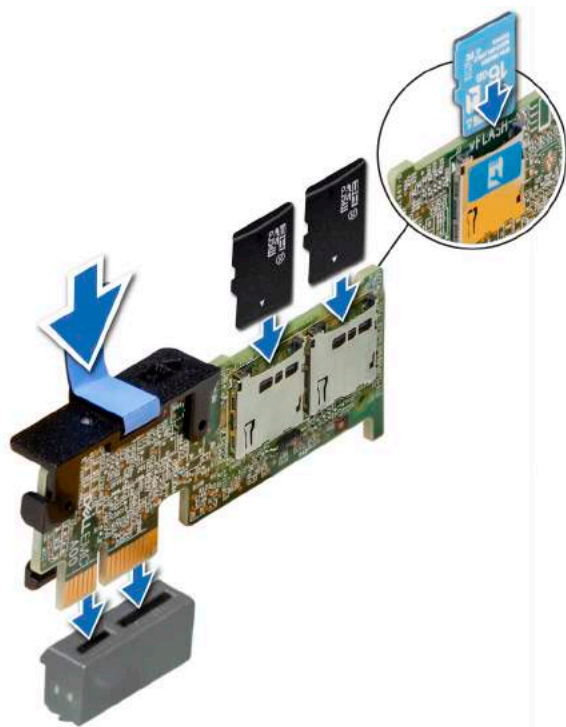

Figure 94. Installing optional IDSDM/vFlash card

#### Next steps

- 1 Install the MicroSD cards.

**NOTE:** Reinstall the MicroSD cards into the same slots based on the labels you had marked on the cards during removal.

- 2 If applicable, install the rear drive cage.
- 3 If applicable, install the full height PCIe card.
- 4 Follow the procedure listed in [After working inside your system](#).

#### Related link

[Installing the micro SD card](#)

[Installing expansion card into expansion card riser](#)

## Network daughter card

The network daughter card (NDC) is a small, removable mezzanine card, which provides the flexibility of selecting different network connectivity options.

## Removing the network daughter card

#### Prerequisites

- 1 Follow the safety guidelines listed in [Safety instructions](#).
- 2 Follow the procedure listed in [Before working inside your system](#).
- 3 Remove the expansion card riser 2 or the rear drive cage, depending on the configuration of your system.

### Steps

- 1 Using a Phillips #2 screwdriver, loosen the captive screws that secure the network daughter card (NDC) to the system board.
- 2 Hold the NDC by the edges on either side of the touch points, and lift to remove it from the connector on the system board.
- 3 Slide the NDC towards the front of the system until the Ethernet connectors are clear of the slot in the back panel.

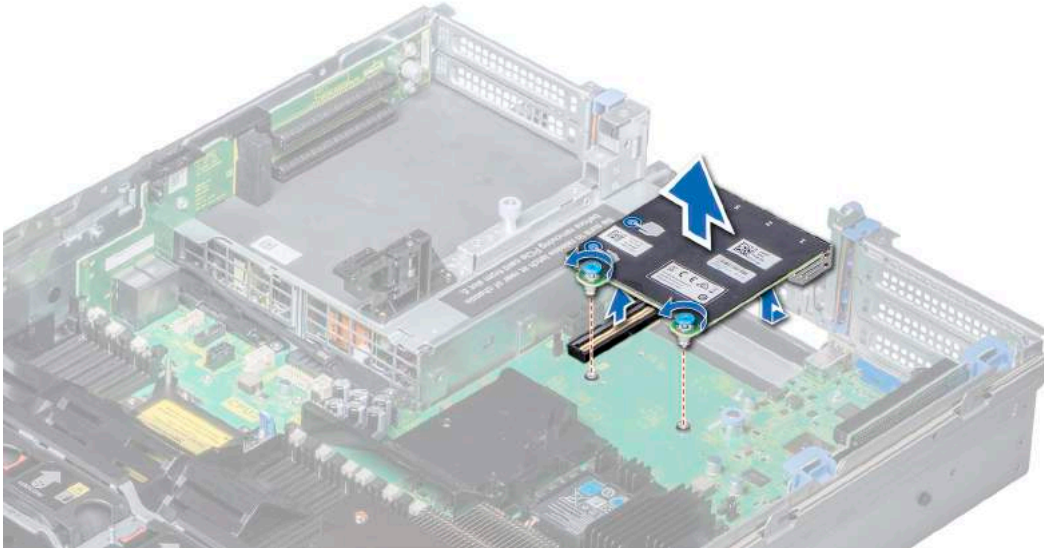

**Figure 95. Removing network daughter card**

### Next step

Install the NDC.

### Related link

[Removing expansion card riser 2](#)

[Installing the network daughter card](#)

## Installing the network daughter card

### Prerequisite

Follow the safety guidelines listed in [Safety instructions](#).

### Steps

- 1 Orient the NDC so that the Ethernet connectors fit through the slot in the chassis.
- 2 Align the captive screws at the back-end of the card with the screw holes on the system board.
- 3 Press the touch points on the card until the card connector is firmly seated on the system board connector.
- 4 Using a Phillips #2 screwdriver, tighten the captive screws to secure the NDC to the system board.

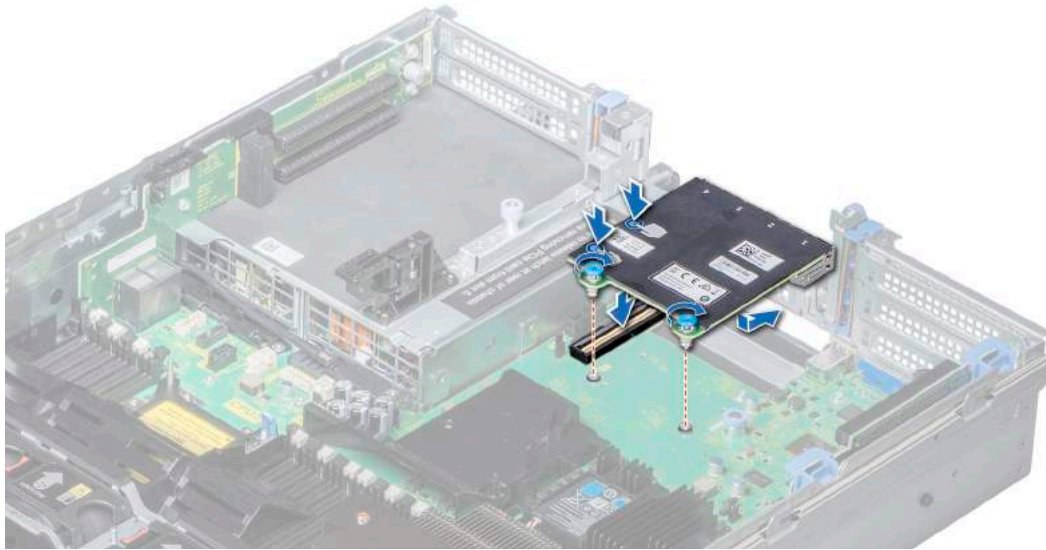

**Figure 96. Installing the network daughter card**

#### Next steps

- 1 Install the expansion card riser 2 or the rear drive cage, depending on the configuration of your system.
- 2 Follow the procedure listed in [After working inside your system](#).

#### Related link

[Installing expansion card riser 2](#)

## Integrated storage controller card

Your system includes a dedicated expansion card slot on the system board for the primary storage controller card. The storage controller card provides the storage subsystem for internal drives of your system. The controller supports SAS and SATA drives and also enables you to set up the drives in RAID configurations as supported by the version of the storage controller.

## Removing integrated storage controller card

#### Prerequisites

- 1 Follow the safety guidelines listed in [Safety instructions](#).
- 2 Follow the procedure listed in [Before working inside your system](#).
- 3 Remove the air shroud.
- 4 Remove the expansion card riser 1.

#### Steps

- 1 Using Phillips #2 screwdriver, loosen the screws that secure the integrated storage controller cable to the system board.
- 2 Lift the integrated storage controller cable away from the integrated storage controller.

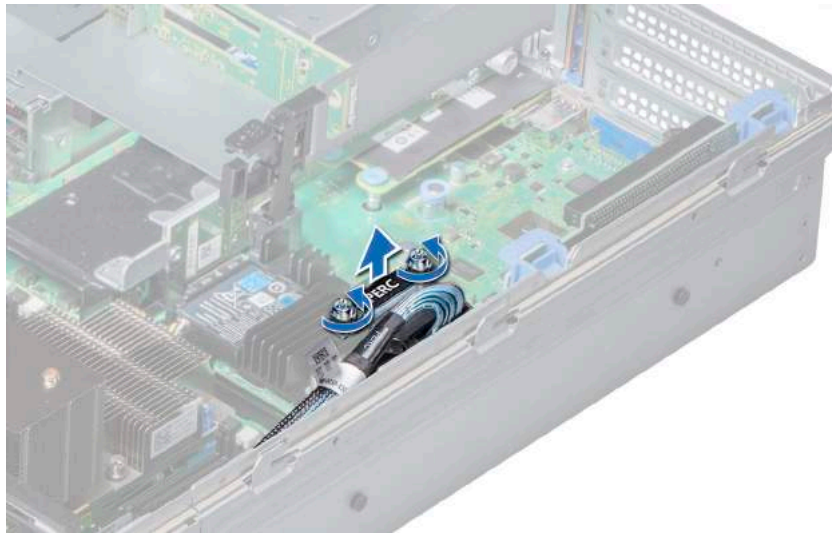

**Figure 97. Removing integrated storage controller cable**

- 3 Lift one end of the card and angle it to disengage the card from the integrated storage controller card holder on the system board.
- 4 Lift the card out of the system.
- 5 Hold the interposer board by its edges, and pull the board until the connector on the board disengages from the connector on the system board.



**Figure 98. Removing integrated storage controller card**

**Next step**

Install the integrated storage controller card.

**Related link**

[Removing the air shroud](#)

[Removing expansion card riser 1](#)

[Installing integrated storage controller card](#)

# Installing integrated storage controller card

## Prerequisite

Follow the safety guidelines listed in [Safety instructions](#).

## Steps

- 1 Hold the interposer board by its edges, and align the interposer board connector with the connector on the system board.
- 2 Press the touch point on the interposer board until the interposer board connector is firmly seated on the system board connector.
- 3 Angle the card to engage the card with the integrated storage controller card holder on the system board.
- 4 Lower the card into place until the card is fully seated in the integrated storage controller card holder.



**Figure 99. Installing integrated storage controller card**

- 5 Align the screws on the integrated storage controller card cable with the screw holes on the system board.
- 6 Using Phillips #2 screwdriver, tighten the screws to secure the integrated storage controller card cable to the system board.

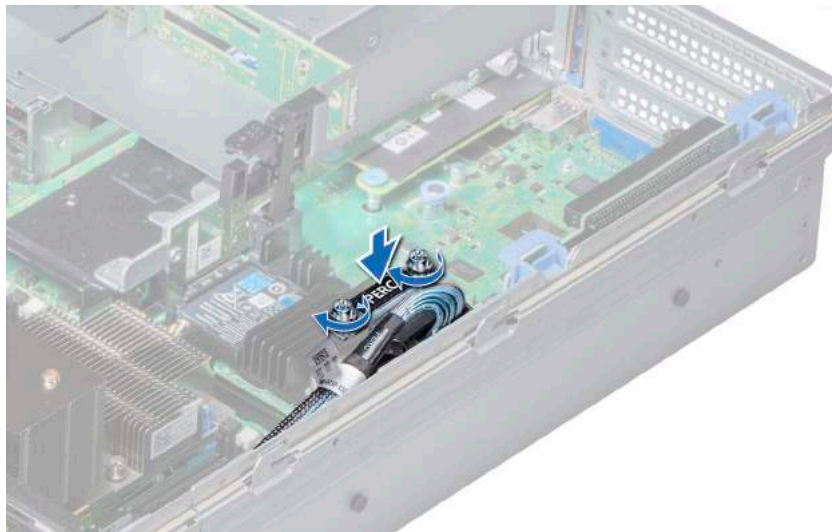

**Figure 100. Installing integrated storage controller card cable**



## Next steps

- 1 Install the expansion card riser 1.
- 2 Install the air shroud.
- 3 Follow the procedure listed in [After working inside your system](#).

## Related link

[Installing expansion card riser 1](#)

[Installing the air shroud](#)

# Drive backplane

Depending on your system configuration, the drive backplanes supported in PowerEdge R740XD are listed here:

**Table 44. Supported backplane options for PowerEdge R740XD systems.**

System	Supported backplane options
PowerEdge R740xd	2.5 inch (x24) SAS/SATA/NVMe backplane or
	2.5 inch (x24) SAS/SATA/NVMe backplane, 2.5 inch (x4) SAS/SATA backplane on the mid drive tray and 2.5 inch (x4) SAS/SATA backplane (back) or
	2.5 inch (x24) SAS/SATA/NVMe backplane which supports 12 SAS/SATA drives and 12 NVMe drives, or
	3.5 inch (x12) SAS/SATA backplane, or
	3.5 inch (x12) SAS/SATA backplane, 3.5 inch (x4) SAS/SATA backplane on the mid drive tray and 3.5 inch (x2) SAS/SATA backplane (back), or
	3.5 inch (x12) SAS/SATA backplane, 3.5 inch (x4) SAS/SATA backplane on the mid drive tray and 2.5 inch (x4) SAS/SATA backplane (back) or
	2.5 inch (x24) NVMe backplane

## Drive backplane connectors

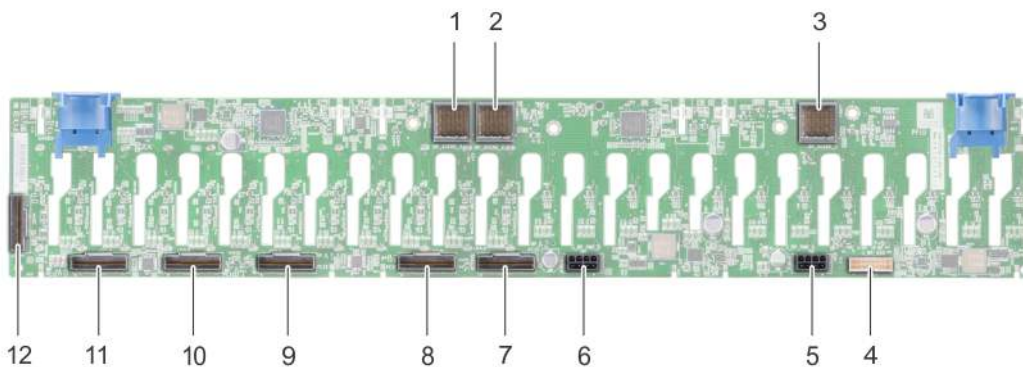

**Figure 101. Back view of 24 x 2.5 inch backplane**

- |   |   |   |  |
|---|---|---|--|
| 1 | backplane to expander board connector (BP_XCEDE_3)  | 2 | backplane to expander board connector (BP_XCEDE_2) |
| 3 | backplane to expander board connector (BP_XCEDE_31) | 4 | signal connector (J_BP_SIG)                        |

- |    |                             |    |                             |
|----|-----------------------------|----|-----------------------------|
| 5  | power connector (J_PWR_A)   | 6  | power connector (J_PWR_B)   |
| 7  | PCIe connector (BP PCIe A2) | 8  | PCIe connector (BP PCIe B2) |
| 9  | PCIe connector (BP PCIe A1) | 10 | PCIe connector (BP PCIe B1) |
| 11 | PCIe connector (BP PCIe A0) | 12 | PCIe connector (BP PCIe B0) |

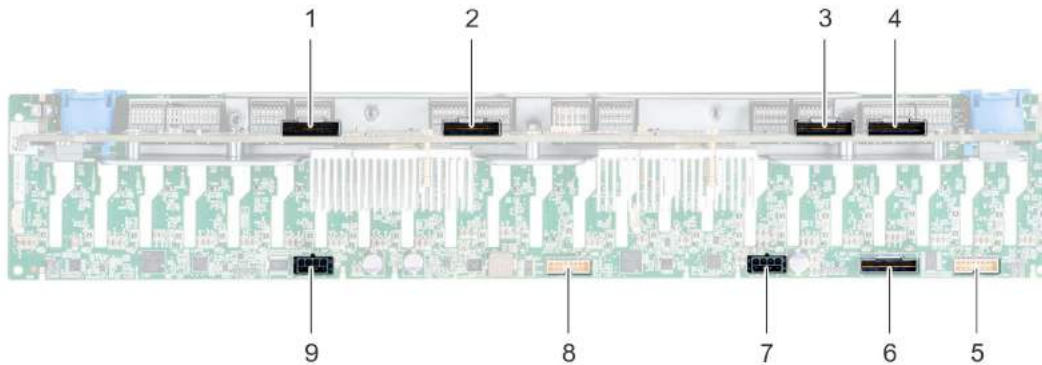

**Figure 102. Back view of 24 x 2.5 inch (24 NVMe) backplane**

- |   |                                     |   |                                     |
|---|-------------------------------------|---|-------------------------------------|
| 1 | expander board connector B1 (PE1_B) | 2 | expander board connector A1 (PE1_A) |
| 3 | expander board connector B2 (PE2_B) | 4 | expander board connector A2 (PE2_A) |
| 5 | signal connector (J_SIG_A1)         | 6 | SAS connector (J_BP_SAS)            |
| 7 | power connector (J_BP_PWR_A1)       | 8 | signal connector (J_SIG_A2)         |
| 9 | power connector (J_BP_PWR_A2)       |   |                                     |

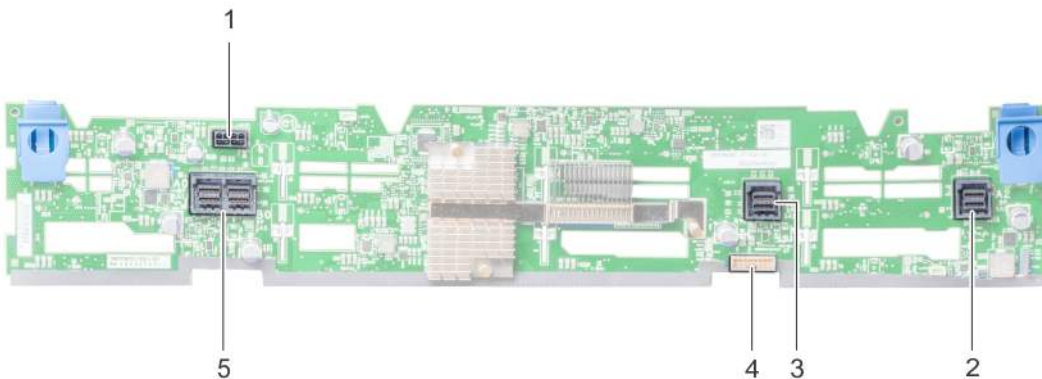

**Figure 103. Back view of 12 x 3.5 inch backplane**

- |   |                             |   |                            |
|---|-----------------------------|---|----------------------------|
| 1 | power connector (J_BP_PWR)  | 2 | SAS connector (A2 BP SAS)  |
| 3 | SAS connector (A1 BP SAS)   | 4 | signal connector (BP SIG1) |
| 5 | SAS connector (J_SAS_A0_B0) |   |                            |





**Figure 104. Back view of 3.5 inch backplane (mid drive tray)**

- |   |                             |   |                          |
|---|-----------------------------|---|--------------------------|
| 1 | power connector (J_BP_PWR)  | 2 | SAS connector (J_SAS_A1) |
| 3 | signal connector (J_BP_SIG) | 4 | SAS connector (J_SAS_B1) |
| 5 | release tab (2)             |   |                          |

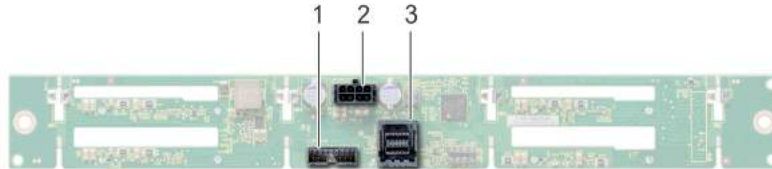

**Figure 105. Back view of 2.5 inch backplane (rear drive cage)**

- |   |                             |   |                              |
|---|-----------------------------|---|------------------------------|
| 1 | signal connector (J_BP_SIG) | 2 | power connector (J_BP_PWR_A) |
| 3 | SAS connector (J_SAS_1)     |   |                              |

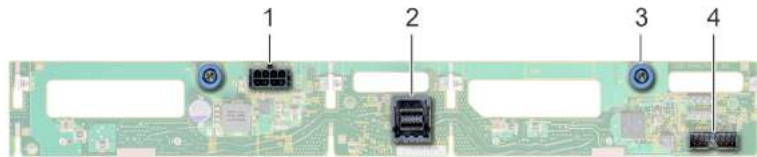

**Figure 106. Back view of 3.5 inch backplane (rear drive cage)**

- |   |                              |   |                             |
|---|------------------------------|---|-----------------------------|
| 1 | power connector (J_BP_PWR_A) | 2 | SAS connector (J_SAS_A)     |
| 3 | release pin (2)              | 4 | signal connector (J_BP_SIG) |

## Removing drive backplane

The procedure to remove the backplane is identical for all backplane configurations.

### Prerequisites

**⚠ CAUTION:** To prevent damage to the drives and backplane, remove the drives from the system before removing the backplane.

**⚠ CAUTION:** Note the number of each drive and temporarily label them before you remove the drive so that you can replace them in the same locations.

- 1 Follow the safety guidelines listed in [Safety instructions](#).
- 2 Follow the procedure listed in [Before working inside your system](#).
- 3 Remove the air shroud.
- 4 Remove the cooling fan assembly.
- 5 Remove the backplane cover.
- 6 Remove all drives.
- 7 Disconnect all the cables from the backplane.

### Step

Press the release tabs and lift the backplane to disengage the backplane from the hooks on the system.

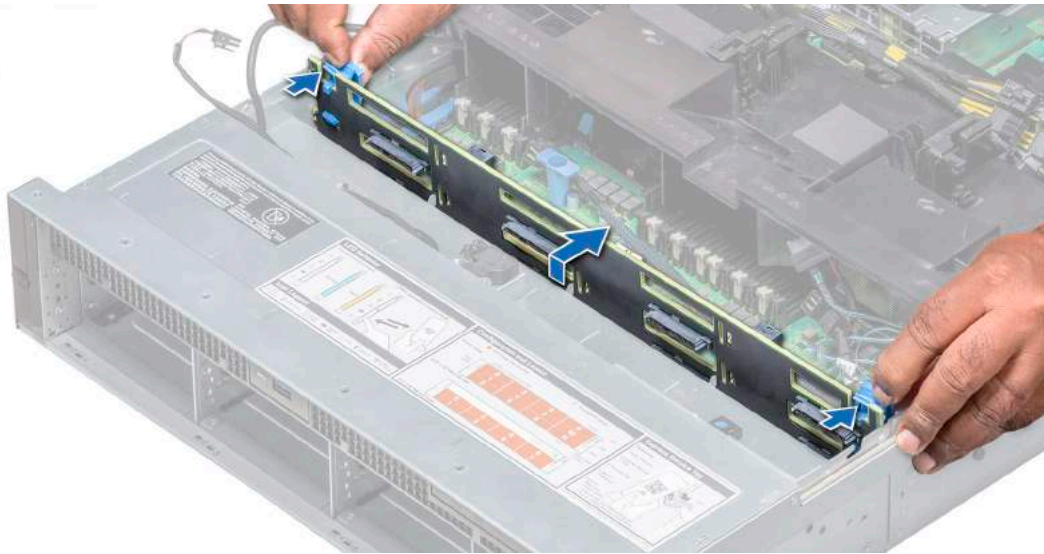

**Figure 107. Removing drive backplane**

**Next step**

Install the drive backplane.

**Related link**

[Installing drive backplane](#)

## Installing drive backplane

The procedure to install the backplane is identical for all backplane configurations.

**Prerequisite**

Follow the safety guidelines listed in [Safety instructions](#).

**NOTE:**

**Steps**

- 1 Use the hooks on the system as guides to align the drive backplane.
- 2 Lower the drive backplane until the release tabs snap into place. If applicable, tighten the captive screws on the backplane.

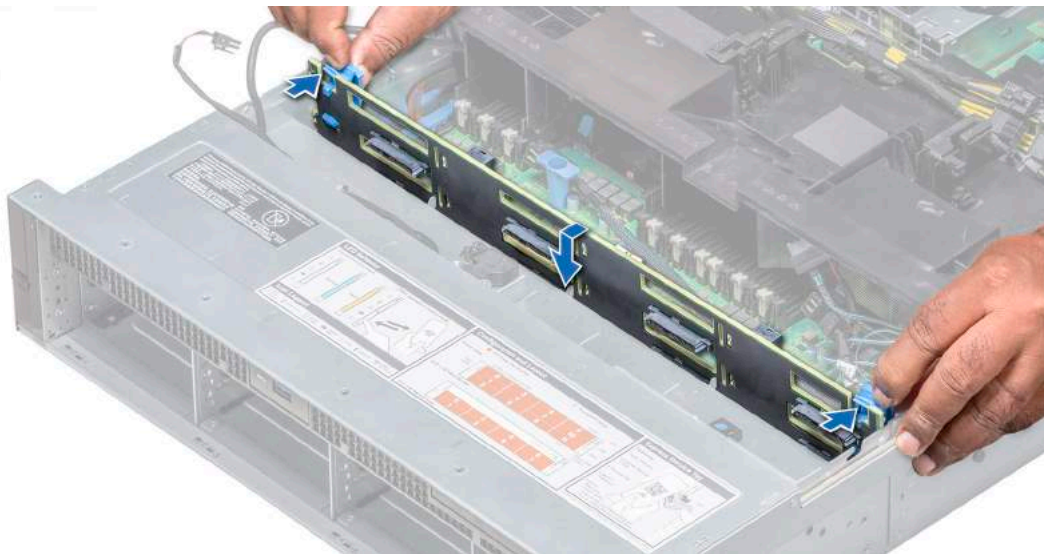

**Figure 108. Installing drive backplane**

#### Next steps

- 1 Connect all the cables to the backplane.
- 2 Install all the drives.
- 3 Install the backplane cover.
- 4 Install the cooling fan assembly.
- 5 Install the air shroud.
- 6 Follow the procedure listed in [After working inside your system](#).

## Removing drive backplane (mid)

The procedure to remove the backplane is identical for 2.5 and 3.5 inch configurations.

#### Prerequisites

- ⚠ **CAUTION:** To prevent damage to the drives and backplane, you must remove the drives from the system before removing the backplane.
- ⚠ **CAUTION:** You must note the number of each drive and temporarily label them before removal so that you can replace them in the same locations.

- 1 Follow the safety guidelines listed in [Safety instructions](#).
- 2 Follow the procedure listed in [Before working inside your system](#).
- 3 Remove all the drive carriers from the mid drive tray.
- 4 Disconnect all the cables from the backplane.

#### Step

Press the release tabs and lift the backplane out of the drive tray.

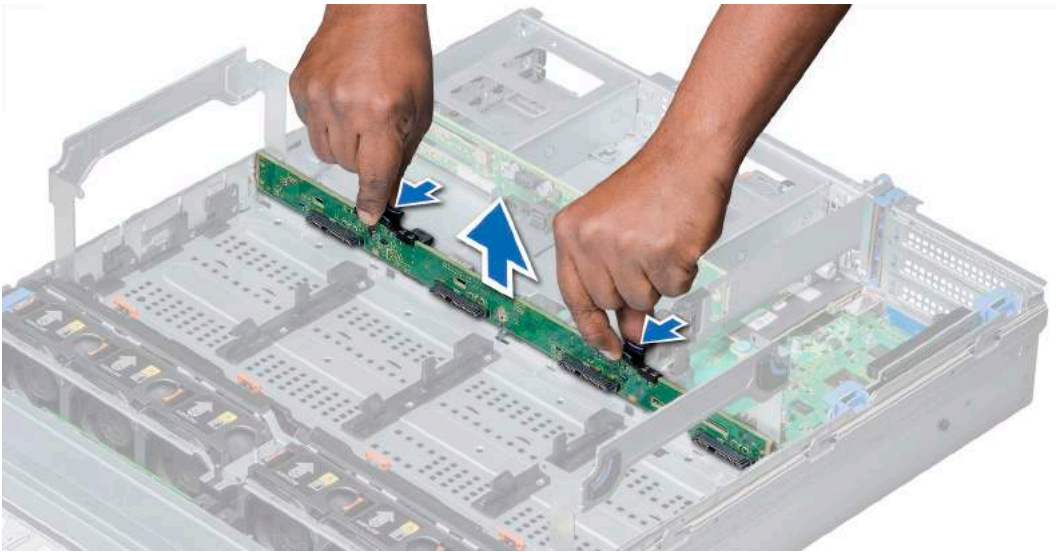

**Figure 109. Removing drive backplane (mid)**

**Next step**

Install the mid drive backplane.

**Related link**

[Removing drive carrier from the mid drive tray](#)

[Installing drive backplane \(mid\)](#)

## Installing drive backplane (mid)

The procedure to install the backplane is identical for 2.5 and 3.5 inch configurations.

**Prerequisite**

Follow the safety guidelines listed in [Safety instructions](#).

**Step**

Align the drive backplane with the guide pin on the system and lower the drive backplane into the system until it is firmly seated.

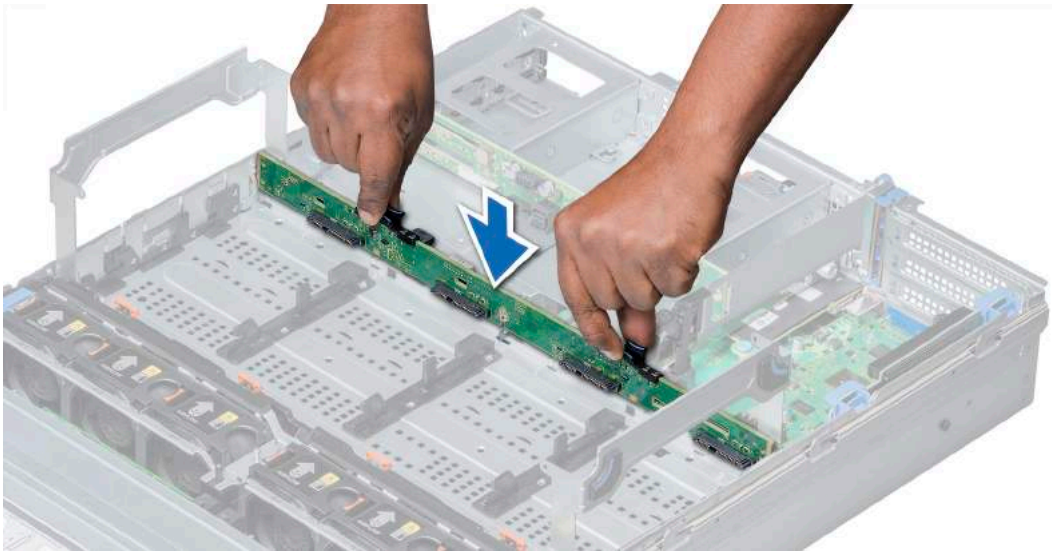

**Figure 110. Installing drive backplane (mid)**

#### Next steps

- 1 Connect all the cables to the backplane.
- 2 Install all the drives carriers into the mid drive tray.
- 3 Follow the procedure listed in [After working inside your system](#).

#### Related link

[Installing drive carrier into mid drive tray](#)

## Removing 3.5 inch drive backplane (rear)

#### Prerequisites

- ⚠ **CAUTION:** To prevent damage to the drives and backplane, you must remove the drives from the system before removing the backplane.
- ⚠ **CAUTION:** You must note the number of each drive and temporarily label them before removal so that you can replace them in the same locations.

- 1 Follow the safety guidelines listed in [Safety instructions](#).
- 2 Follow the procedure listed in [Before working inside your system](#).
- 3 Remove all the drives.
- 4 Disconnect all the cables from the backplane.

#### Steps

- 1 Pull the release pins, and lift the drive backplane to disengage the backplane from the hooks on the rear drive module.
- 2 Remove the backplane from the system.



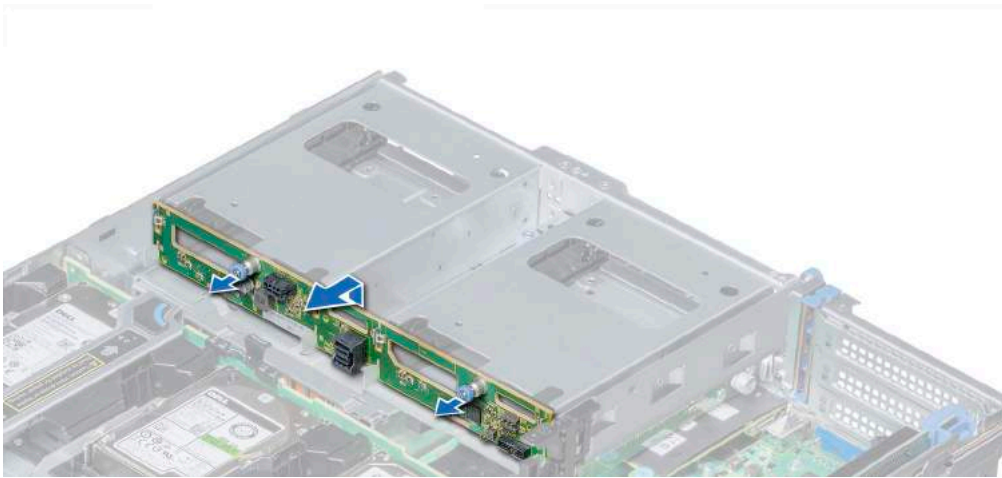

**Figure 111. Removing 3.5 inch drive backplane (rear)**

**Next step**

Install the rear 3.5 inch drive backplane.

**Related link**

[Removing a drive carrier](#)

[Installing 3.5 inch drive backplane \(rear\)](#)

## Installing 3.5 inch drive backplane (rear)

**Prerequisite**

Follow the safety guidelines listed in [Safety instructions](#).

**Steps**

- 1 Use the hooks on the rear drive module as guides to align the drive backplane.
- 2 Lower the backplane into the system until it is firmly seated.

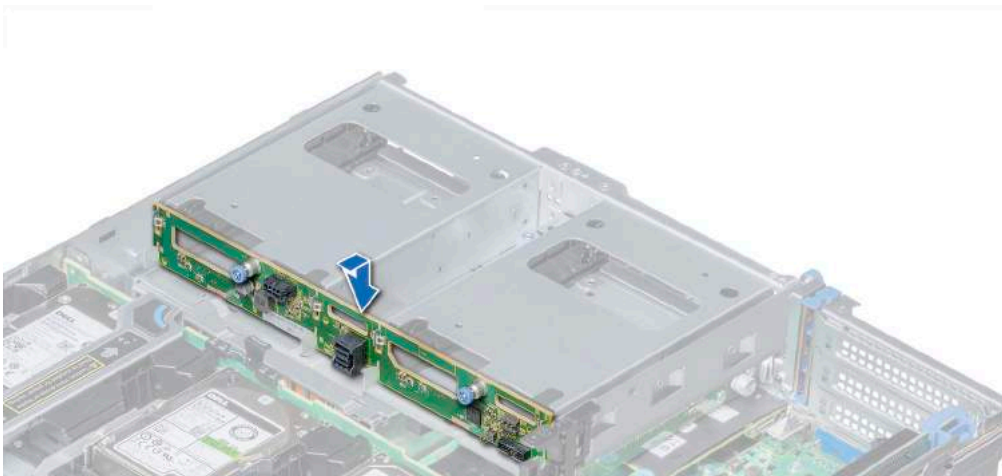

**Figure 112. Installing 3.5 inch drive backplane (rear)**

**Next steps**

- 1 Install all the drives.

- 2 Connect all the cables to the backplane.
- 3 Follow the procedure listed in [After working inside your system](#).

**Related link**

[Installing a drive carrier](#)

## Removing the 2.5 inch drive backplane (rear)

**Prerequisites**

- ⚠ **CAUTION:** To prevent damage to the drives and backplane, you must remove the drives from the system before removing the backplane.
- ⚠ **CAUTION:** You must note the number of each drive and temporarily label them before removal so that you can replace them in the same locations.

- 1 Follow the safety guidelines listed in [Safety instructions](#).
- 2 Follow the procedure listed in [Before working inside your system](#).
- 3 Remove all the drives from the rear drive cage.
- 4 Disconnect all the cables from the backplane.

**Steps**

- 1 Using Phillips #2 screwdriver, remove the screws that secure the drive backplane to the rear drive cage.
- 2 Disengage the backplane from the hooks on the rear drive cage, and remove it from the rear drive cage.

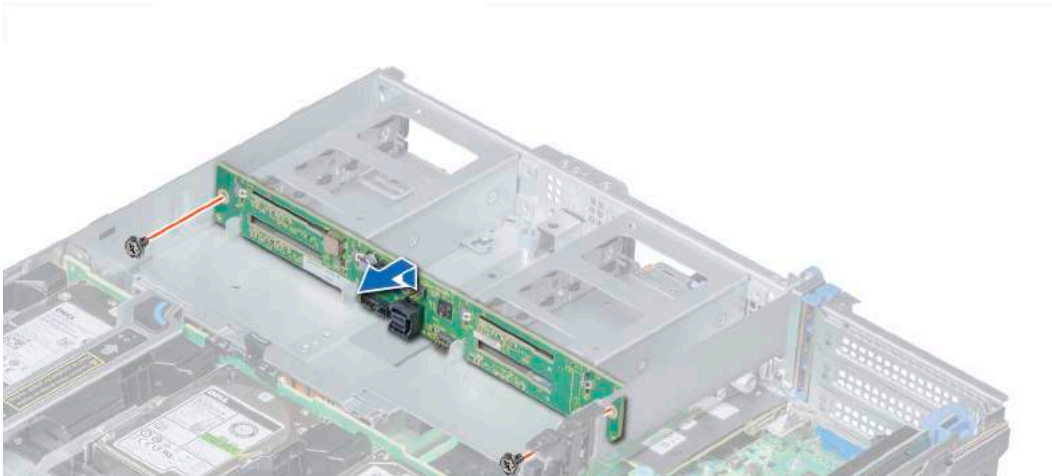

**Figure 113. Removing 2.5 inch drive backplane (rear)**

**Next step**

Install the rear 2.5 inch drive backplane.

**Related link**

[Removing a drive carrier](#)

[Installing the 2.5 inch drive backplane \(rear\)](#)

## Installing the 2.5 inch drive backplane (rear)

**Prerequisite**

Follow the safety guidelines listed in [Safety instructions](#).



## Steps

- 1 Use the hooks on the rear drive cage as guides to align the drive backplane.
- 2 Lower the backplane into the system until it is firmly seated.
- 3 Using Phillips #2 screwdriver, replace the screws to secure the backplane to the rear drive cage.

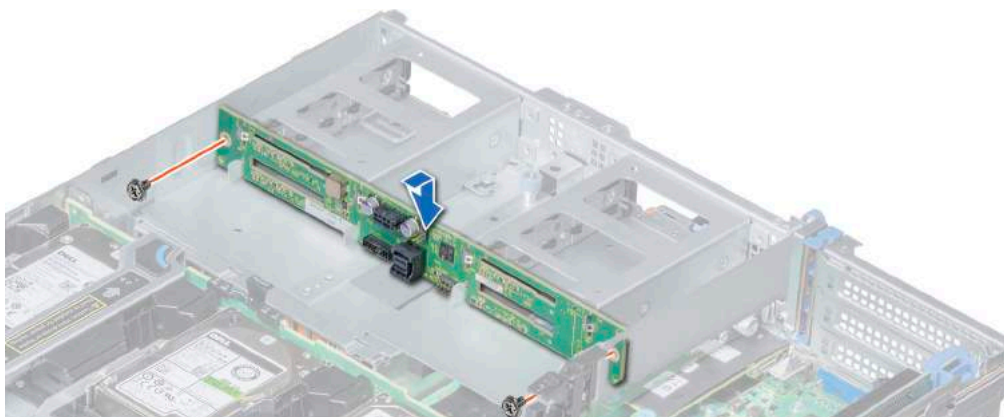

**Figure 114. Installing 2.5 inch drive backplane (rear)**

## Next steps

- 1 Install all the drives.
- 2 Connect all the cables to the backplane.
- 3 Follow the procedure listed in [After working inside your system](#).

## Related link

[Installing a drive carrier](#)

## Cable routing

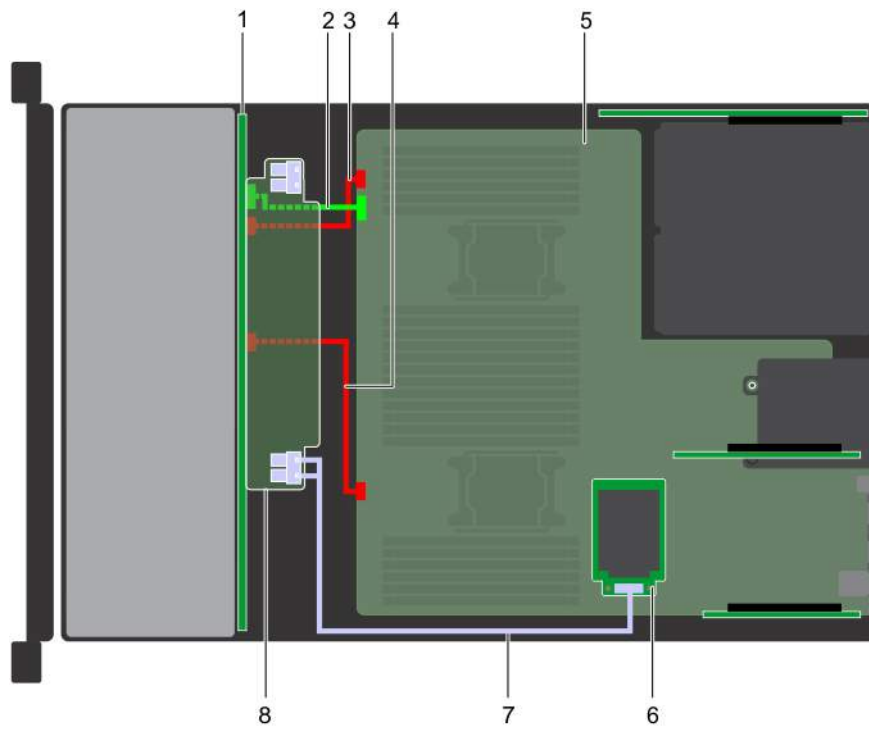

**Figure 115. Cable routing – 24 x 2.5 inch drive backplane with mini PERC**

- |   |                         |   |                         |
|---|-------------------------|---|-------------------------|
| 1 | backplane               | 2 | backplane signal cable  |
| 3 | backplane power cable A | 4 | backplane power cable B |
| 5 | system board            | 6 | mini PERC               |
| 7 | SAS cable               | 8 | backplane expander      |

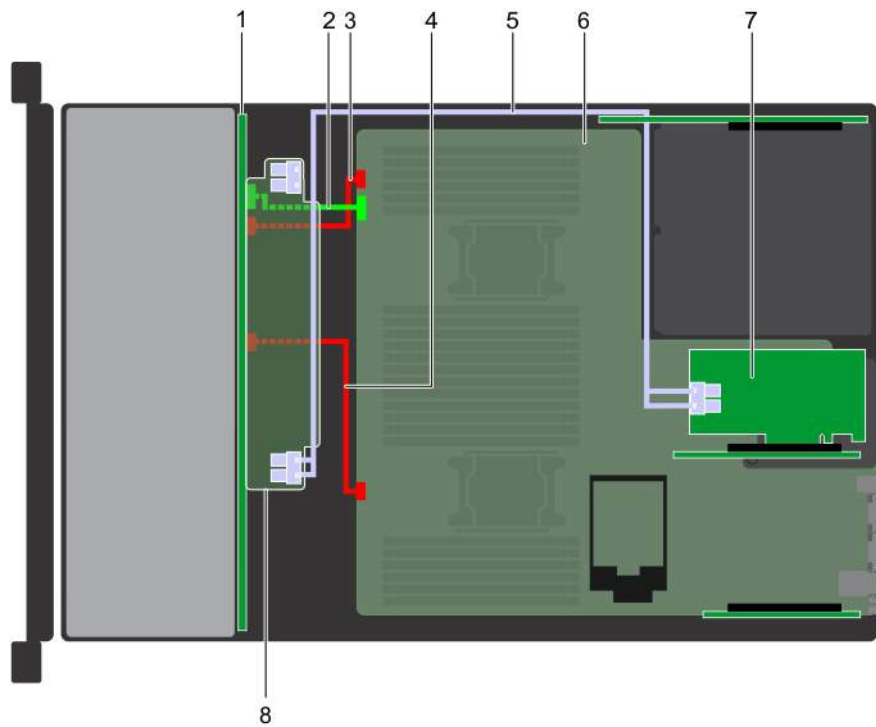

**Figure 116. Cable routing – 24 x 2.5 inch drive backplane with adapter PERC**

- |   |                         |   |                         |
|---|-------------------------|---|-------------------------|
| 1 | backplane               | 2 | backplane signal cable  |
| 3 | backplane power cable A | 4 | backplane power cable B |
| 5 | SAS cable               | 6 | system board            |
| 7 | adapter PERC            | 8 | backplane expander      |

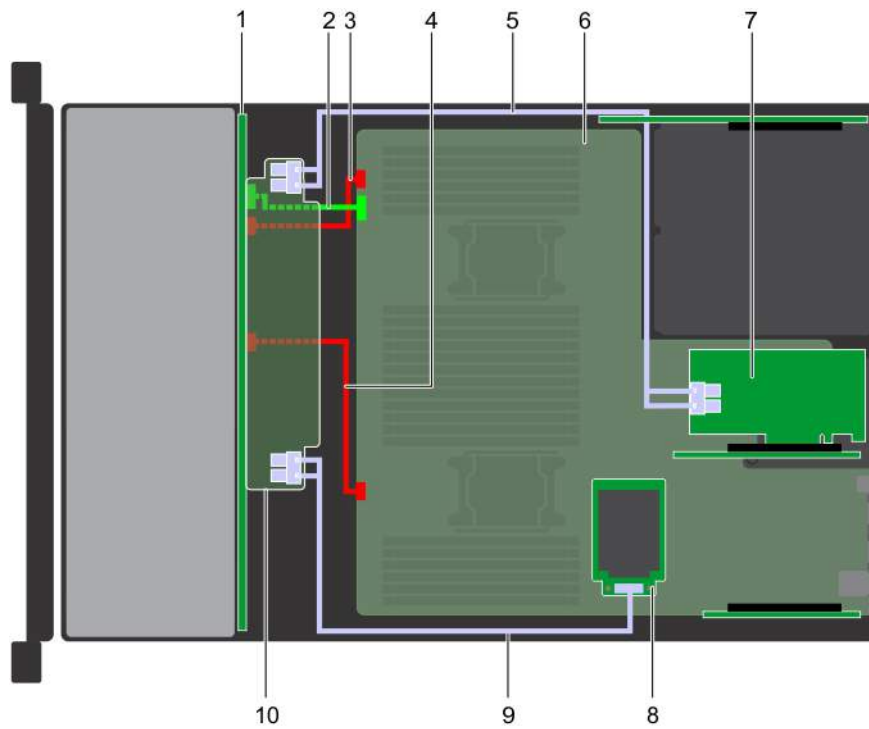

**Figure 117. Cable routing – 24 x 2.5 inch drive backplane with mini PERC and adapter PERC**

- |   |                         |    |                         |
|---|-------------------------|----|-------------------------|
| 1 | backplane               | 2  | backplane signal cable  |
| 3 | backplane power cable A | 4  | backplane power cable B |
| 5 | SAS cable               | 6  | system board            |
| 7 | adapter PERC            | 8  | mini PERC               |
| 9 | SAS cable               | 10 | backplane expander      |

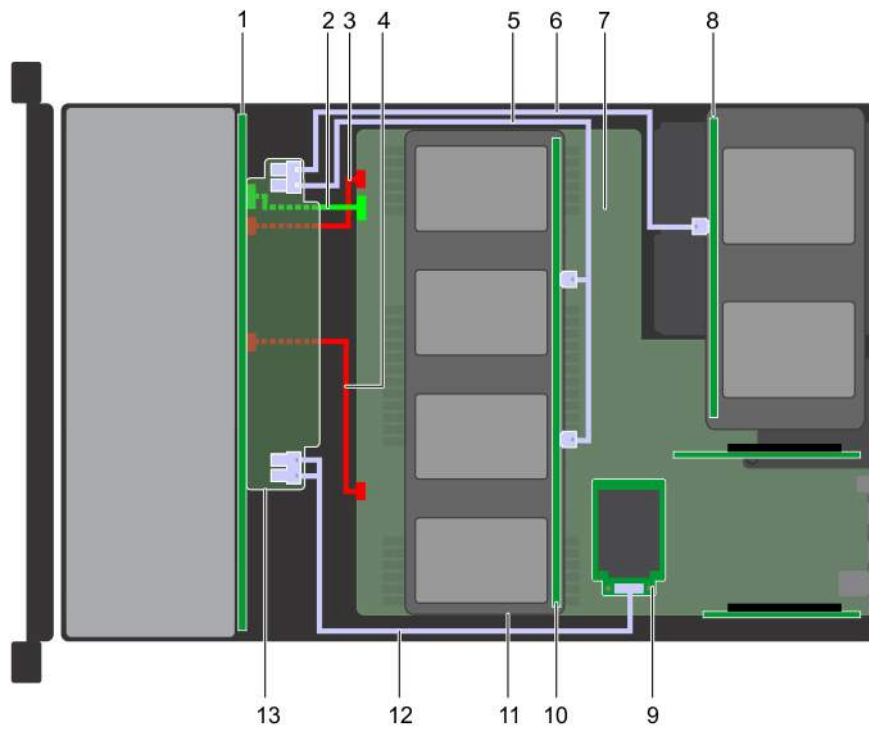

**Figure 118. Cable routing – 24 x 2.5 inch drive backplane with 4 x 3.5 (with 4 x 2.5 adapter) mid drive tray and 4 x 2.5 rear drive cage**

- |    |  |    |                         |
|----|--|----|-------------------------|
| 1  | backplane                                  | 2  | backplane signal cable  |
| 3  | backplane power cable A                    | 4  | backplane power cable B |
| 5  | SAS cable                                  | 6  | SAS cable               |
| 7  | system board                               | 8  | rear drive backplane    |
| 9  | mini PERC                                  | 10 | mid drive backplane     |
| 11 | 4 x 3.5 (with 4 x 2.5 adapter) inch drives | 12 | SAS cable               |
| 13 | backplane expander                         |    |                         |

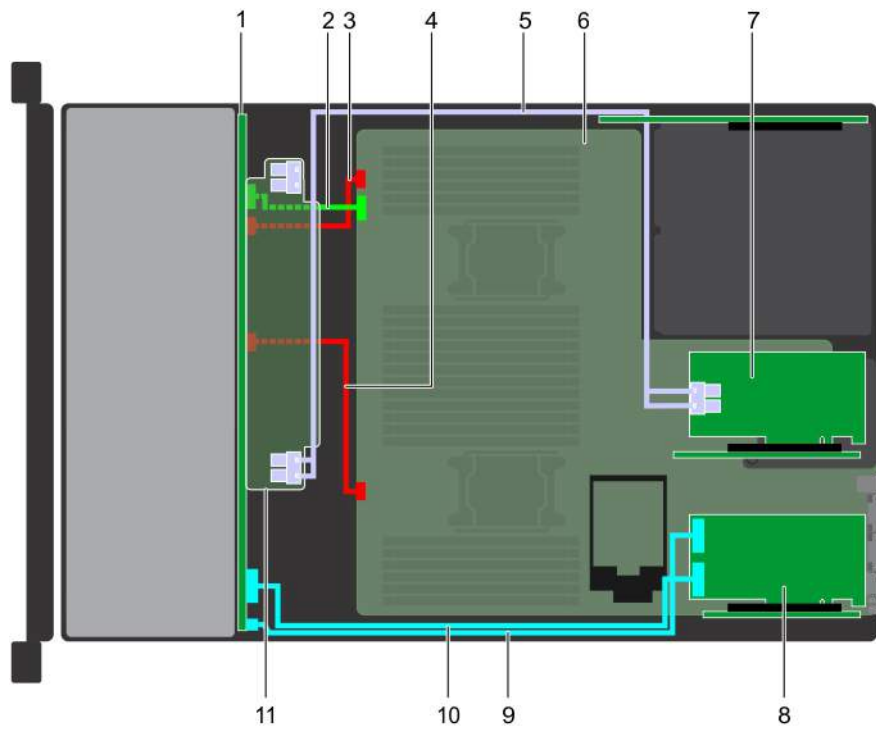

**Figure 119. Cable routing – 24 x 2.5 inch drive backplane with 20 SAS plus 4 PCIe and adapter PERC**

- |    |                         |    |                         |
|----|-------------------------|----|-------------------------|
| 1  | backplane               | 2  | backplane signal cable  |
| 3  | backplane power cable A | 4  | backplane power cable B |
| 5  | SAS cable               | 6  | system board            |
| 7  | adapter PERC            | 8  | PCIe card               |
| 9  | PCIe cable A            | 10 | PCIe cable B            |
| 11 | backplane expander      |    |                         |

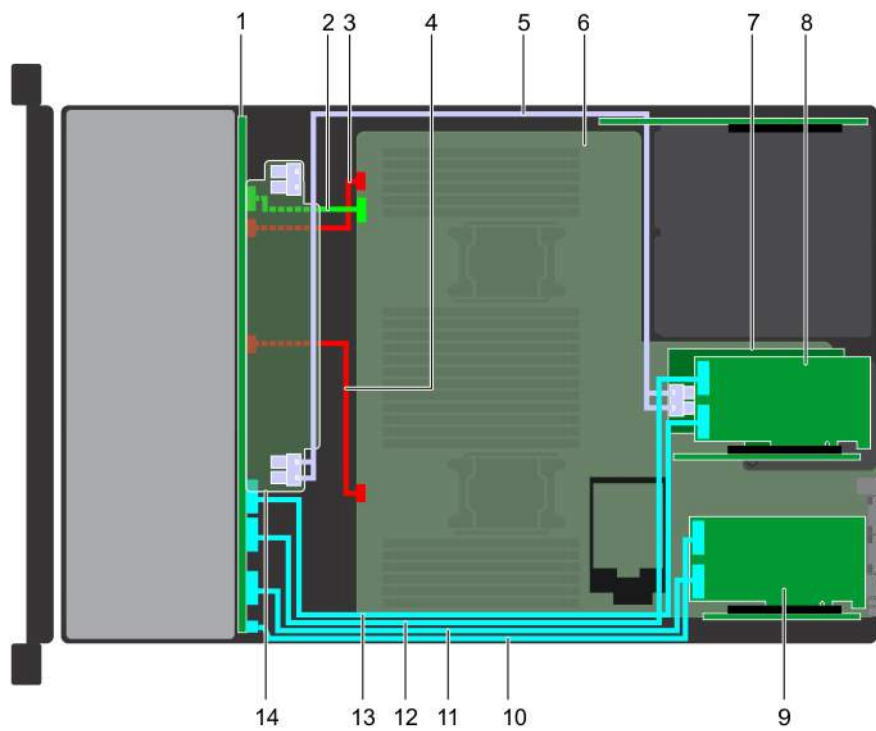

**Figure 120. Cable routing – 24 x 2.5 inch drive backplane with 16 SAS plus 8 PCIe and adapter PERC**

- |    |                                   |    |                                  |
|----|-----------------------------------|----|----------------------------------|
| 1  | backplane                         | 2  | backplane signal cable           |
| 3  | backplane power cable A           | 4  | backplane power cable B          |
| 5  | SAS cable                         | 6  | system board                     |
| 7  | adapter PERC on riser 2A (slot 6) | 8  | PCIe card 1 on riser 2A (slot 4) |
| 9  | PCIe card 2 on riser 1A (slot 1)  | 10 | PCIe cable A of PCIe card 2      |
| 11 | PCIe cable B of PCIe card 2       | 12 | PCIe cable A of PCIe card 1      |
| 13 | PCIe cable B of PCIe card 1       | 14 | backplane expander               |



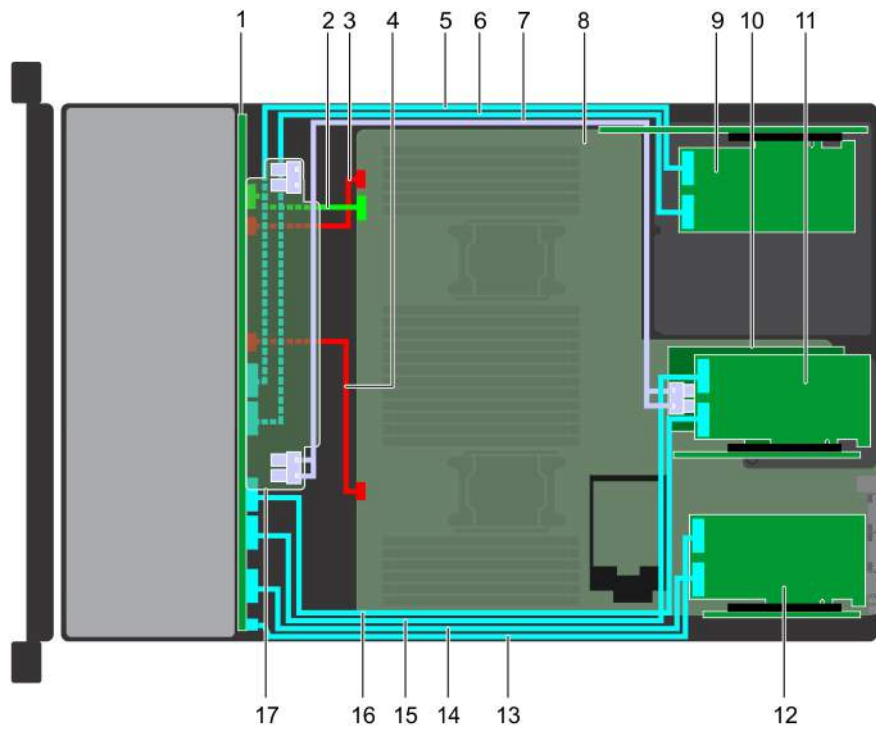

**Figure 121. Cable routing – 24 x 2.5 inch drive backplane with 12 SAS plus 12 PCIe and adapter PERC**

- |    |                                  |    |                                   |
|----|----------------------------------|----|-----------------------------------|
| 1  | backplane                        | 2  | backplane signal cable            |
| 3  | backplane power cable A          | 4  | backplane power cable B           |
| 5  | PCIe cable A of PCIe card 1      | 6  | PCIe cable B of PCIe card 1       |
| 7  | SAS cable                        | 8  | system board                      |
| 9  | PCIe card 1 on riser 3A (slot 8) | 10 | adapter PERC on riser 2A (slot 6) |
| 11 | PCIe card 2 on riser 2A (slot 4) | 12 | PCIe card 3 on riser 1A (slot 1)  |
| 13 | PCIe cable A of PCIe card 3      | 14 | PCIe cable B of PCIe card 3       |
| 15 | PCIe cable A of PCIe card 2      | 16 | PCIe cable B of PCIe card 2       |
| 17 | backplane expander               |    |                                   |

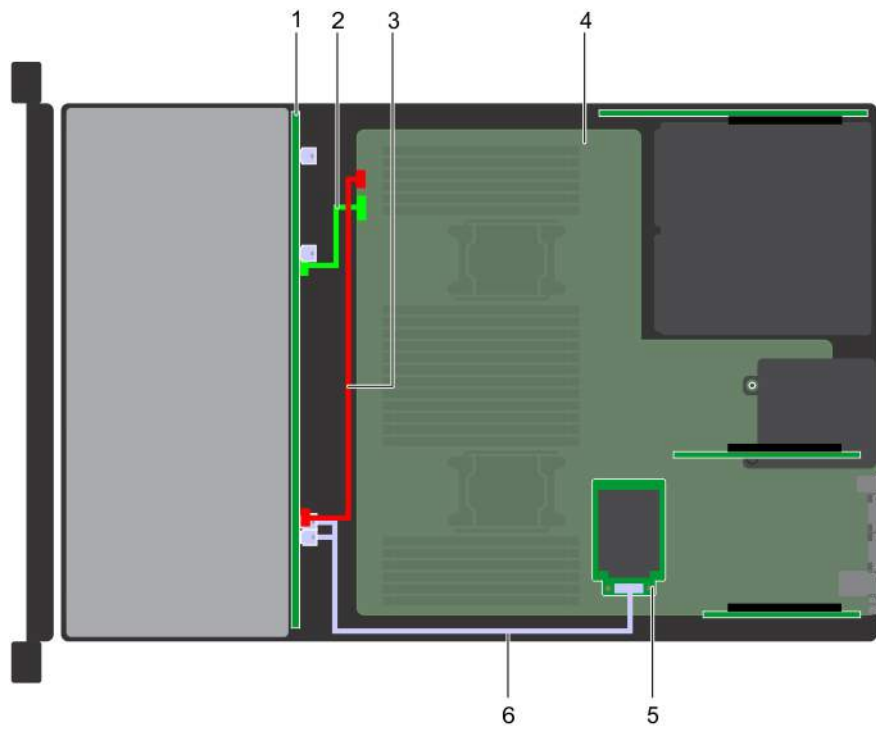

**Figure 122. Cable routing – 12 x 3.5 inch drive backplane with mini PERC**

- |   |                       |   |                        |
|---|-----------------------|---|------------------------|
| 1 | backplane             | 2 | backplane signal cable |
| 3 | backplane power cable | 4 | system board           |
| 5 | mini PERC             | 6 | SAS cable              |

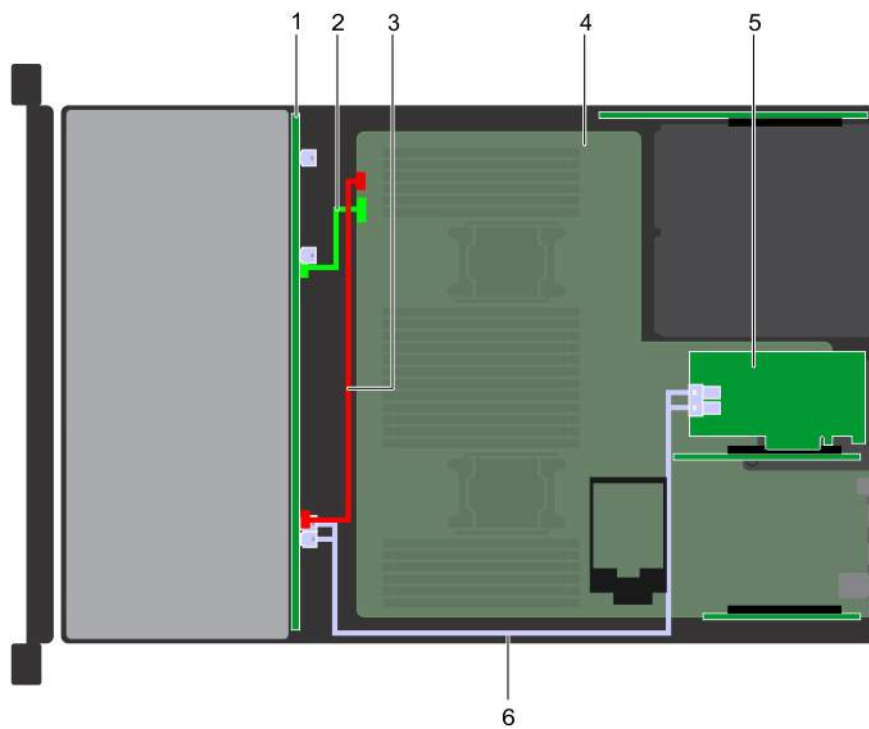

**Figure 123. 12 x 3.5 inch drive backplane with adapter PERC**

- |   |                       |   |                        |
|---|-----------------------|---|------------------------|
| 1 | backplane             | 2 | backplane signal cable |
| 3 | backplane power cable | 4 | system board           |
| 5 | adapter PERC          | 6 | SAS cable              |

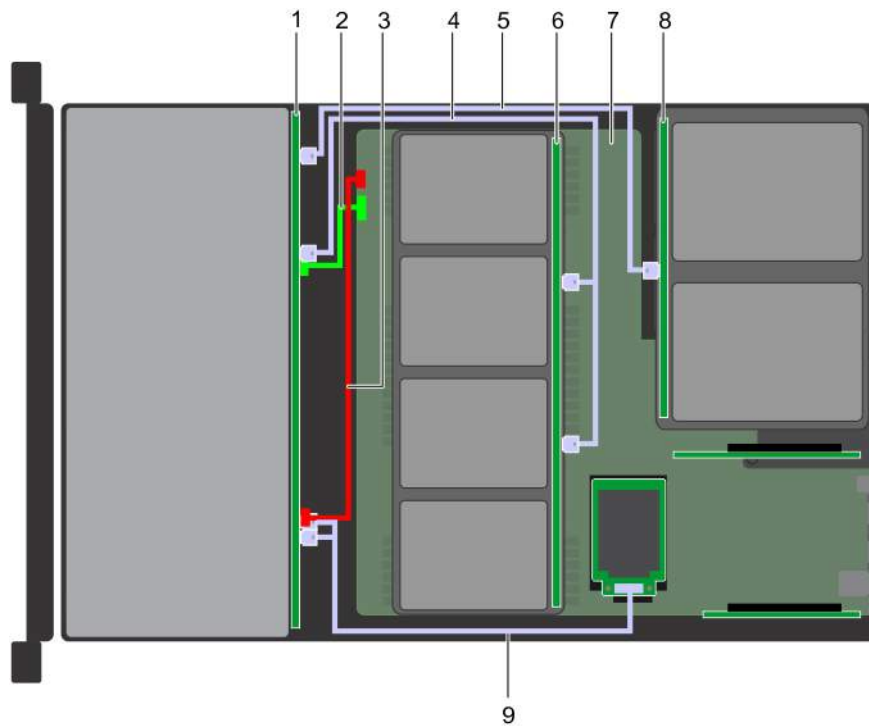

**Figure 124. Cable routing – 12 x 3.5 inch drive backplane with 4 x 3.5 mid drive tray and 2 x 3.5 rear drive cage**

- |   |                       |   |                        |
|---|-----------------------|---|------------------------|
| 1 | backplane             | 2 | backplane signal cable |
| 3 | backplane power cable | 4 | SAS cable              |
| 5 | SAS cable             | 6 | mid drive backplane    |
| 7 | system board          | 8 | rear drive backplane   |
| 9 | SAS cable             |   |                        |

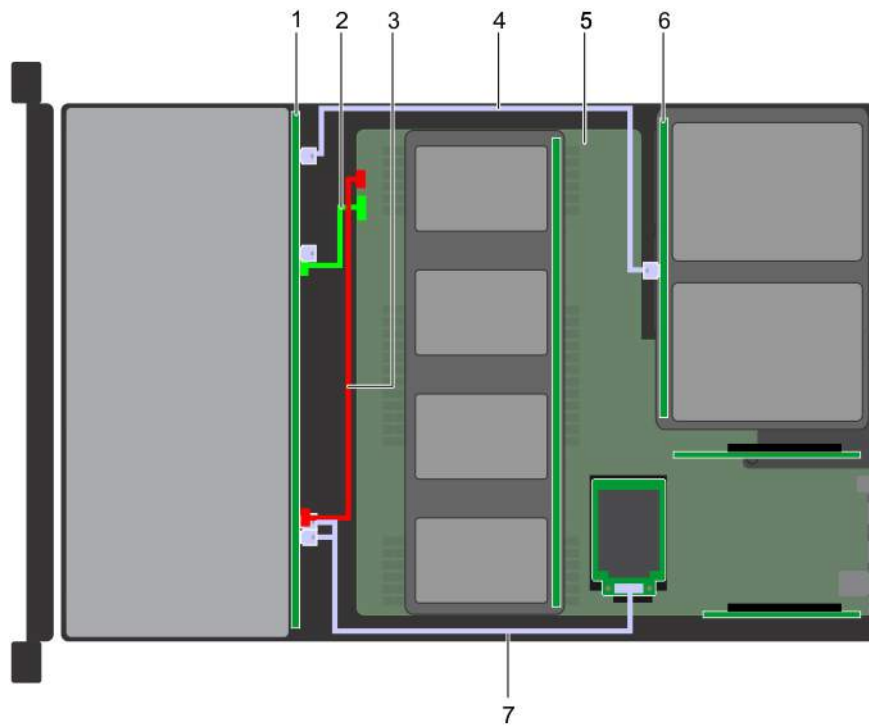

**Figure 125. Cable routing – 12 x 3.5 inch drive backplane with 4 x 2.5 mid drive tray and 2 x 3.5 rear drive cage**

- |   |                       |   |                        |
|---|-----------------------|---|------------------------|
| 1 | backplane             | 2 | backplane signal cable |
| 3 | backplane power cable | 4 | SAS cable              |
| 5 | system board          | 6 | rear drive backplane   |
| 7 | SAS cable             |   |                        |

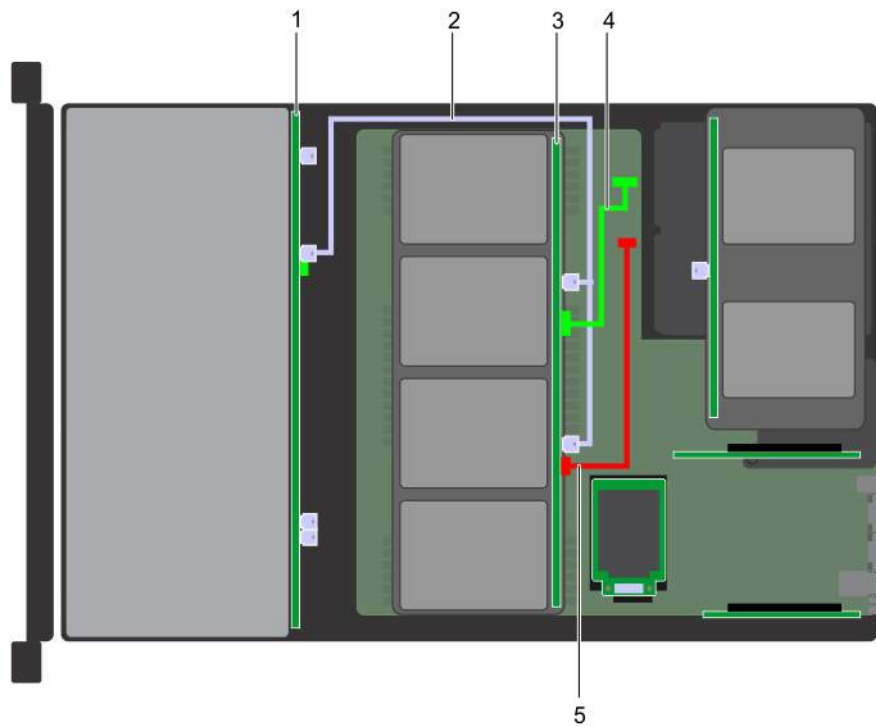

**Figure 126. Cable routing – 4 x 3.5 mid drive backplane with 12 x 3.5 inch drive backplane**

- |   |                           |   |                            |
|---|---------------------------|---|----------------------------|
| 1 | backplane                 | 2 | SAS cable                  |
| 3 | mid drive backplane       | 4 | mid backplane signal cable |
| 5 | mid backplane power cable |   |                            |

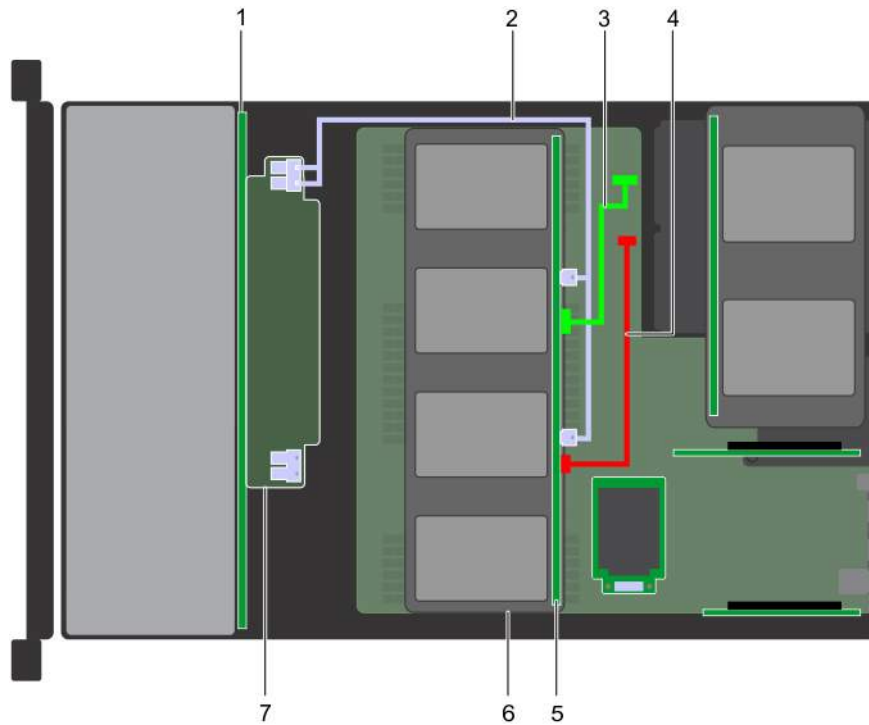

**Figure 127. Cable routing – 4 x 2.5 mid drive backplane with 24 x 2.5 inch drive backplane**

- |   |                            |   |                           |
|---|----------------------------|---|---------------------------|
| 1 | backplane                  | 2 | SAS cable                 |
| 3 | mid backplane signal cable | 4 | mid backplane power cable |
| 5 | mid drive backplane        | 6 | 4 x 2.5 inch drives       |
| 7 | backplane expander         |   |                           |

## System battery

The system battery is used for low-level system functions such as powering the real-time and date settings of the system.

## Replacing the system battery

### Prerequisites

**⚠ WARNING:** There is a danger of a new battery exploding if it is incorrectly installed. Replace the battery only with the same or equivalent type recommended by the manufacturer. For more information, see the safety information that shipped with your system.

- 1 Follow the safety guidelines listed in [Safety instructions](#).
- 2 Follow the procedure listed in [Before working inside your system](#).
- 3 If applicable, close the PCIe card holder latch on the air shroud to release the full length card.
- 4 If applicable, disconnect the power or data cables from expansion card(s).
- 5 Remove the expansion card riser 1A.

### Steps

- 1 Locate the battery socket. For more information, see the System board jumpers and connectors section.



**CAUTION:** To avoid damage to the battery connector, you must firmly support the connector while installing or removing a battery.

- 2 Use a plastic scribe to pry out the system battery as shown in the following illustration:



**Figure 128. Removing the system battery**

- 3 To install a new system battery, hold the battery with the positive side facing up and slide it under the securing tabs.
- 4 Press the battery into the connector until it snaps into place.



**Figure 129. Installing the system battery**

#### Next steps

- 1 Install the expansion card riser 1A.
- 2 If applicable, connect the cables to the expansion card(s).
- 3 If applicable, open the PCIe card holder latch on the air shroud to secure the full length expansion card.
- 4 Follow the procedure listed in [After working inside your system](#).
- 5 While booting, press F2 to enter the System Setup and ensure that the battery is operating properly.
- 6 Enter the correct time and date in the System Setup **Time** and **Date** fields.
- 7 Exit the System Setup.

#### Related link

[Opening and closing the PCIe card holder latch](#)  
[Removing expansion card riser 1](#)  
[Installing expansion card riser 1](#)

## Internal USB memory key (optional)

An optional USB memory key can be installed in the internal USB 3.0 port and can be used as a boot device, security key or mass storage device.

The internal USB port is on the system board.

**NOTE:** To locate the internal USB port on the system board, see the [System board jumpers and connectors](#) section.

#### Related link

[System board jumpers and connectors](#)

# Replacing optional internal USB memory key

## Prerequisites

**CAUTION:** To avoid interference with other components in the server, the maximum permissible dimensions of the USB memory key are 15.9 mm wide x 57.15 mm long x 7.9 mm high.

- 1 Follow the safety guidelines listed in [Safety instructions](#).
- 2 Follow the procedure listed in [Before working inside your system](#).

## Steps

- 1 Locate the USB port or USB memory key on the system board.  
To locate the USB port, see the Internal USB memory key (optional) section.
- 2 If installed, remove the USB memory key from the USB port.
- 3 Insert the replacement USB memory key into the USB port.

## Next steps

- 1 Follow the procedure listed in [After working inside your system](#).
- 2 While booting, press F2 to enter **System Setup** and verify that the system detects the USB memory key.

## Related link

[Internal USB memory key \(optional\)](#)

# Power supply units

The power supply unit (PSU) is an internal hardware component which supplies power to the components in the system.

Your system supports one of the following:

- Two 2000 W, 1600 W, 1100 W, 750 W, or 495 W AC PSUs
- Two 1100 W DC PSUs
- Two 1100 W or 750 W Mixed Mode HVDC PSUs

**NOTE:** For more information, see the [Technical specifications section](#).

**CAUTION:** If two PSUs are installed, both the PSUs must have the same type of label. For example, Extended Power Performance (EPP) label. Mixing PSUs from previous generations of PowerEdge servers is not supported, even if the PSUs have the same power rating. Mixing PSUs will result in mismatch condition or failure to turn the system on.

**NOTE:** Titanium PSU is nominally rated for 200 V AC to 240 V AC input only.

**NOTE:** When two identical PSUs are installed, power supply redundancy (1+1 – with redundancy or 2+0 – without redundancy) is configured in system BIOS. In redundant mode, power is supplied to the system equally from both PSUs when Hot Spare is disabled. When Hot Spare is enabled, one of the PSUs is put into the sleep mode when system utilization is low in order to maximize efficiency.

**NOTE:** If two PSUs are used, they must be of the same maximum output power.

## Related link

[Technical specifications](#)

# Hot spare feature

Your system supports the hot spare feature that significantly reduces the power overhead associated with power supply unit (PSU) redundancy.

When the hot spare feature is enabled, one of the redundant PSUs is switched to the sleep state. The active PSU supports 100 percent of the system load, thus operating at higher efficiency. The PSU in the sleep state monitors output voltage of the active PSU. If the output voltage of the active PSU drops, the PSU in the sleep state returns to an active output state.

If having both PSUs active is more efficient than having one PSU in the sleep state, the active PSU can also activate the sleeping PSU.

The default PSU settings are as follows:

- If the load on the active PSU is more than 50 percent of PSU rated power wattage, then the redundant PSU is switched to the active state.
- If the load on the active PSU falls below 20 percent of PSU rated power wattage, then the redundant PSU is switched to the sleep state.

You can configure the hot spare feature by using the iDRAC settings. For more information, see the iDRAC User's Guide available at [Dell.com/idracmanuals](http://Dell.com/idracmanuals).

# Removing a power supply unit blank

### Prerequisite

Follow the safety guidelines listed in [Safety instructions](#).

### Step

If you are installing a second PSU, remove the PSU blank in the bay by pulling the blank outward.

**CAUTION:** To ensure proper system cooling, the PSU blank must be installed in the second PSU bay in a non-redundant configuration. Remove the PSU blank only if you are installing a second PSU.



Figure 130. Removing a power supply unit blank

### Next step

Install the PSU blank.

### Related link

[Installing a power supply unit blank](#)

# Installing a power supply unit blank

## Prerequisites

- 1 Follow the safety guidelines listed in [Safety instructions](#).
- 2 Install the power supply unit (PSU) blank only in the second PSU bay.

## Step

Align the PSU blank with the PSU slot and push it into the PSU slot until it clicks into place.



Figure 131. Installing a power supply unit blank

# Removing a power supply unit

The procedure for removing AC and DC PSUs is identical.

## Prerequisites

**⚠ CAUTION:** The system needs one power supply unit (PSU) for normal operation. On power-redundant systems, remove and replace only one PSU at a time in a system that is powered on.

- 1 Follow the safety guidelines listed in [Safety instructions](#).
- 2 Disconnect the power cable from the power source and from the PSU you intend to remove, and then remove the cable from the strap on the PSU handle.
- 3 Unlatch and lift the optional cable management arm if it interferes with the PSU removal.  
For information about the cable management arm, see the system's rack documentation at [Dell.com/poweredgemanuals](https://Dell.com/poweredgemanuals).

## Step

Press the release latch and slide the PSU out of the system by using the PSU handle.



**Figure 132. Removing a power supply unit**

**Next step**

Install the PSU or the PSU blank.

**Related link**

[Installing a power supply unit](#)

[Installing a power supply unit blank](#)

## Installing a power supply unit

The procedure for installing AC and DC PSUs is identical.

**Prerequisites**

- 1 Follow the safety guidelines listed in [Safety instructions](#).
- 2 For systems that support redundant PSU, ensure that both the PSUs are of the same type and have the same maximum output power.

**NOTE:** The maximum output power (shown in watts) is listed on the PSU label.

**Step**

Slide the PSU into the system until the PSU is fully seated and the release latch snaps into place.

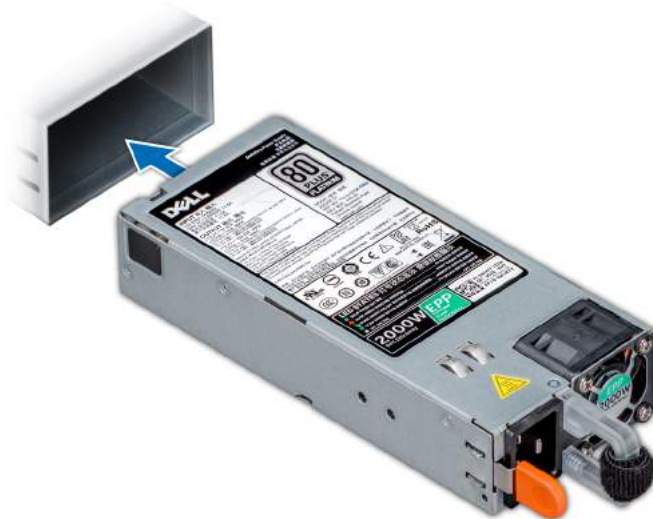

Figure 133. Installing a power supply unit

#### Next steps

- 1 If you have unlatched the cable management arm, relatch it. For information about the cable management arm, see the system's rack documentation at [Dell.com/poweredgemanuals](http://Dell.com/poweredgemanuals).
- 2 Connect the power cable to the PSU, and plug the cable into a power outlet.

**CAUTION:** When connecting the power cable to the PSU, secure the cable to the PSU with the strap.

**NOTE:** When installing, hot swapping, or hot adding a new PSU, wait for 15 seconds for the system to recognize the PSU and determine its status. The PSU redundancy may not occur until discovery is complete. Wait until the new PSU is discovered and enabled before you remove the other PSU. The PSU status indicator turns green to signify that the PSU is functioning properly.

## Wiring instructions for a DC power supply unit

Your system supports up to two  $-(48-60)$  V DC power supply units (PSUs).

**WARNING:** For equipment using  $-(48-60)$  V DC power supply units (PSUs), a qualified electrician must perform all connections to DC power and to safety grounds. Do not attempt connecting to DC power or installing grounds yourself. All electrical wiring must comply with applicable local or national codes and practices. Damage due to servicing that is not authorized by Dell is not covered by your warranty. Read and follow all safety instructions that came with the product.

**CAUTION:** Wire the unit with copper only, unless otherwise specified, use only 10 American Wire Gauge (AWG) wire rated minimum  $90^{\circ}\text{C}$  for source and return. Protect the  $-(48-60)$  V DC (1 wire) with a branch circuit over-current protection rated 50 A for DC with a high interrupt current rating.

**CAUTION:** Connect the equipment to a  $-(48-60)$  V DC supply source that is electrically isolated from the AC source (reliably grounded  $-(48-60)$  V DC SELV source). Ensure that the  $-(48-60)$  V DC source is efficiently secured to earth (ground).

**NOTE:** A readily accessible disconnect device that is suitably approved and rated shall be incorporated in the field wiring.

## Input requirements

- Supply voltage:  $-(48-60)$  V DC

- Current consumption: 32 A (maximum)

## Kit contents

- Dell part number 6RYJ9 terminal block or equivalent (1)
- #6-32 nut equipped with lock washer (1)

## Required tools

Wire-stripper pliers capable of removing insulation from size 10 AWG solid or stranded, insulated copper wire.

**NOTE:** Use alpha wire part number 3080 or equivalent (65/30 stranding).

## Required wires

- One UL 10 AWG, 2 m maximum (stranded) black wire [–(48–60) V DC].
- One UL 10 AWG, 2 m maximum (stranded) red wire (V DC return).
- One UL 10 AWG, 2 m maximum, green with a yellow stripe, stranded wire (safety ground).

## Assembling and connecting safety ground wire

### Prerequisite

**WARNING:** For equipment using –(48–60) V DC power supply units (PSUs), a qualified electrician must perform all connections to DC power and to safety grounds. Do not attempt connecting to DC power or installing grounds yourself. All electrical wiring must comply with applicable local or national codes and practices. Damage due to servicing that is not authorized by Dell is not covered by your warranty. Read and follow all safety instructions that came with the product.

### Steps

- 1 Strip the insulation from the end of the green or yellow wire, exposing approximately 4.5 mm (0.175 inch) of copper wire.
- 2 Using a hand-crimping tool (Tyco Electronics, 58433-3 or equivalent), crimp the ring-tongue terminal (Jeeson Terminals Inc., R5-4SA or equivalent) to the green and yellow wire (safety ground wire).
- 3 Connect the safety ground wire to the grounding post on the back of the system by using a #6-32 nut equipped with a locking washer.

## Assembling DC input power wires

### Prerequisite

**WARNING:** For equipment using –(48–60) V DC power supply units (PSUs), a qualified electrician must perform all connections to DC power and to safety grounds. Do not attempt connecting to DC power or installing grounds yourself. All electrical wiring must comply with applicable local or national codes and practices. Damage due to servicing that is not authorized by Dell is not covered by your warranty. Read and follow all safety instructions that came with the product.

### Steps

- 1 Strip the insulation from the ends of the DC power wires, exposing approximately 13 mm (0.5 inch) of copper wire.

**WARNING:** Reversing polarity when connecting DC power wires can permanently damage the power supply or the system.

- 2 Insert the copper ends into the mating connectors and tighten the captive screws at the top of the mating connector using a Phillips #2 screwdriver.



**⚠ WARNING:** To protect the power supply from electrostatic discharge, the captive screws must be covered with the rubber cap before inserting the mating connector into the power supply.

- 3 Rotate the rubber cap clockwise to fix it over the captive screws.
- 4 Insert the mating connector into the power supply.

## System board

A system board (also known as the motherboard) is the main printed circuit board in the system with different connectors used to connect different components or peripherals of the system. A system board provides the electrical connections to the components in the system to communicate.

## Removing system board

### Prerequisites

**⚠ CAUTION:** If you are using the Trusted Platform Module (TPM) with an encryption key, you may be prompted to create a recovery key during program or System Setup. Be sure to create and safely store this recovery key. If you replace this system board, you must supply the recovery key when you restart your system or program before you can access the encrypted data on your drives.

**⚠ CAUTION:** Do not attempt to remove the TPM plug-in module from the system board. Once the TPM plug-in module is installed, it is cryptographically bound to that specific system board. Any attempt to remove an installed TPM plug-in module breaks the cryptographic binding, and it cannot be re-installed or installed on another system board.

- 1 Follow the safety guidelines listed in [Safety instructions](#).
- 2 Follow the procedure listed in [Before working inside your system](#).
- 3 Remove the following:
  - a Air shroud
  - b Cooling fan assembly
  - c Rear drive cage (if applicable)
  - d Mid drive tray (if applicable)
  - e Power supply unit(s)
  - f All expansion card risers
  - g Integrated storage controller card
  - h iDSDM/vFlash card
  - i Internal USB key (if applicable)
  - j Processor and heat sink module
  - k Processors and DIMM blank

**⚠ CAUTION:** To prevent damage to the processor pins when replacing a faulty system board, ensure that you cover the processor socket with the processor protective cap.

- l Memory modules and memory module blanks
- m Network daughter card

### Steps

- 1 Disconnect all cables from the system board.

**⚠ CAUTION:** Take care not to damage the system identification button while removing the system board from the chassis.

**⚠ CAUTION:** Do not lift the system board by holding a memory module, processor, or other components.

- 2 Holding the system board holder, pull the blue release pin, lift the system board, and then slide it toward the front of the chassis. Sliding the system board toward the front of the chassis disengages the connectors from the back of the chassis slots.
- 3 Lift the system board out of the chassis.

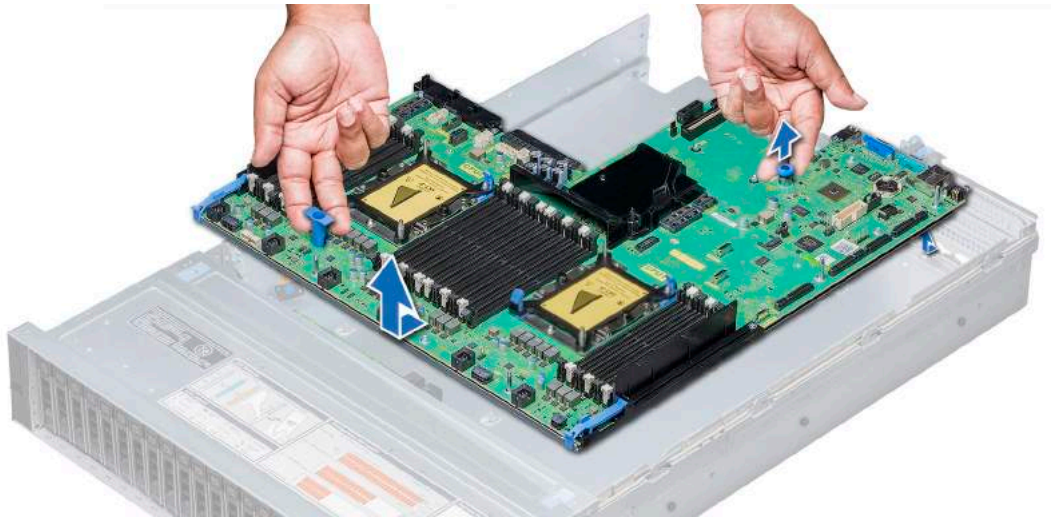

**Figure 134. Removing system board**

### Next step

Install the system board.

### Related link

- [Removing the air shroud](#)
- [Removing the cooling fan assembly](#)
- [Removing mid drive tray](#)
- [Removing rear drive cage](#)
- [Removing a power supply unit](#)
- [Removing expansion card riser 1](#)
- [Removing expansion card riser 2](#)
- [Removing expansion card riser 3](#)
- [Removing integrated storage controller card](#)
- [Removing the optional IDSDM or vFlash card](#)
- [Replacing optional internal USB memory key](#)
- [Removing a processor and heat sink module](#)
- [Removing a memory module](#)
- [Removing the network daughter card](#)
- [Installing system board](#)

## Installing system board

### Prerequisite

Follow the safety guidelines listed in [Safety instructions](#).

### Steps

1. Unpack the replacement system board assembly.

**⚠ CAUTION: Do not lift the system board by holding a memory module, processor, or other components.**

**⚠ CAUTION: Take care not to damage the system identification button while placing the system board into the chassis.**

2. Holding the system board holder and blue release pin, push the system board toward the back of the system until the release pin clicks into place.

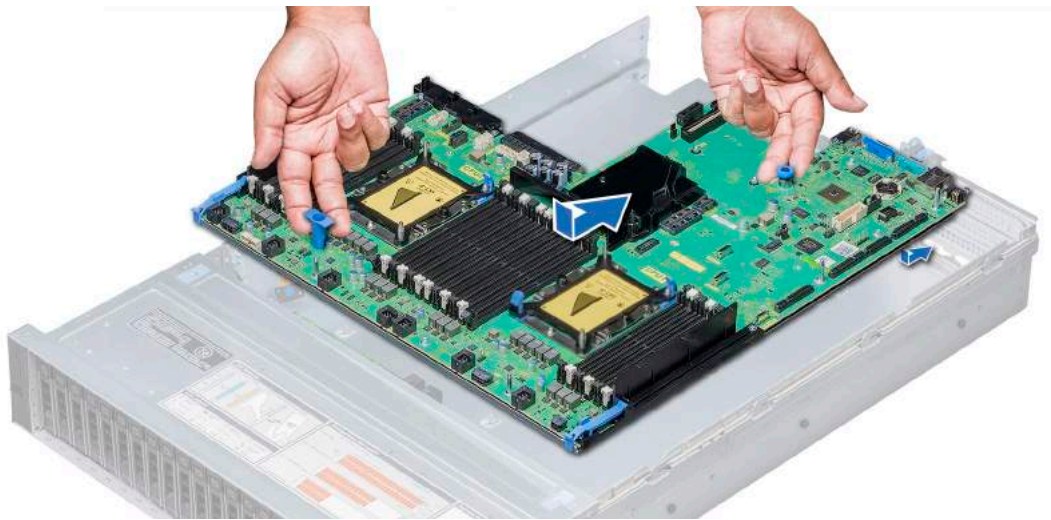

**Figure 135. Installing system board**

### Next steps

- 1 Install the Trusted Platform Module (TPM).

**NOTE:** The TPM plug-in module is attached to the system board and cannot be removed. A replacement TPM plug-in module will be provided for all system board replacements where a TPM plug-in module was installed.

- 2 Replace the following:
  - a Mid drive tray (if applicable)
  - b Rear drive cage (if applicable)
  - c Integrated storage controller card
  - d Internal USB key (if applicable)
  - e iDSDM/vFlash card
  - f All expansion card risers
  - g Processor and heat sink module
  - h Processor and DIMM blank
  - i Memory modules and memory module blanks
  - j Network daughter card
  - k Cooling fan assembly
  - l Air shroud
  - m Power supply unit(s)

- 3 Reconnect all cables to the system board.

**NOTE:** Ensure that the cables inside the system are routed along the chassis wall and secured using the cable securing bracket.

- 4 Follow the procedure listed in [After working inside your system](#).

- 5 Ensure that you:
  - a Use the Easy Restore feature to restore the Service Tag. For more information, see the Easy restore section.
  - b If the Service Tag is not backed up in the backup flash device, enter the Service Tag manually. For more information, see the Entering the Service Tag section.
  - c Update the BIOS and iDRAC versions.
  - d Re-enable the Trusted Platform Module (TPM). For more information, see the Re-enabling the Trusted Platform Module (TPM) section.
- 6 Import your new or existing iDRAC Enterprise license.

For more information, see Integrated Dell Remote Access Controller User's Guide, at [Dell.com/esmmanuals](https://www.dell.com/esmmanuals).

#### Related link

- [Installing the mid drive tray](#)
- [Installing rear drive cage](#)
- [Replacing the Trusted Platform Module](#)
- [Installing integrated storage controller card](#)
- [Replacing optional internal USB memory key](#)
- [Installing optional IDSDM or vFlash card](#)
- [Installing expansion card riser 1](#)
- [Installing expansion card riser 2](#)
- [Installing expansion card riser 3](#)
- [Installing a processor and heat sink module](#)
- [Installing a memory module](#)
- [Installing the network daughter card](#)
- [Installing a cooling fan](#)
- [Installing the air shroud](#)
- [Installing a power supply unit](#)

## Entering the system Service Tag by using System Setup

If Easy Restore fails to restore the Service Tag, use System Setup to enter the Service Tag.

- 1 Turn on the system.
- 2 Press F2 to enter System Setup.
- 3 Click **Service Tag Settings**.
- 4 Enter the Service Tag.

**NOTE:** You can enter the Service Tag only when the Service Tag field is empty. Ensure that you enter the correct Service Tag. After the Service Tag is entered, it cannot be updated or changed.

- 5 Click **Ok**.
- 6 Import your new or existing iDRAC Enterprise license.

For more information, see the *Integrated Dell Remote Access Controller User's Guide* at [Dell.com/idracmanuals](https://www.dell.com/idracmanuals).

## Restoring the Service Tag by using the Easy Restore feature

By using the Easy Restore feature, you can restore your Service Tag, license, UEFI configuration, and the system configuration data after replacing the system board. All data is automatically backed up in a backup flash device. If BIOS detects a new system board and the Service Tag in the backup flash device, BIOS prompts the user to restore the backup information.

- 1 Turn on the system.  
If BIOS detects a new system board, and if the Service Tag is present in the backup flash device, BIOS displays the Service Tag, the status of the license, and the **UEFI Diagnostics** version.
- 2 Perform one of the following steps:  
After the restore process is complete, BIOS prompts to restore the system configuration data.
- 3 Perform one of the following steps:
  - Press **Y** to restore the system configuration data.
  - Press **N** to use the default configuration settings.

After the restore process is complete, the system restarts.

# Trusted Platform Module

Trusted Platform Module (TPM) is a dedicated microprocessor designed to secure hardware by integrating cryptographic keys into devices. Software can use a TPM to authenticate hardware devices. Because each TPM chip has a unique and secret RSA key which is embedded during the manufacture of the TPM, it is capable of performing platform authentication operation.

## Replacing the Trusted Platform Module

### Prerequisites

- 1 Follow the safety guidelines listed in [Safety instructions](#).
- 2 Follow the procedure listed in [Before working inside your system](#).

### NOTE:

- Ensure that your operating system supports the version of the TPM module being installed.
- Ensure that you download and install the latest BIOS firmware on your system.
- Ensure that the BIOS is configured to enable UEFI boot mode.

### Steps

- 1 Locate the TPM connector on the system board.

**NOTE:** To locate the TPM connector on the system board, see the [System board jumpers and connectors](#) section.

- 2 Press to hold the module down and remove the screw using the security Torx 8-bit shipped with the TPM module.
- 3 Slide the TPM module out from its connector.
- 4 Push the plastic rivet away from the TPM connector and rotate it 90° counterclockwise to release it from the system board.
- 5 Pull the plastic rivet out of its slot on the system board.
- 6 To install the TPM, align the edge connectors on the TPM with the slot on the TPM connector.
- 7 Insert the TPM into the TPM connector such that the plastic rivet aligns with the slot on the system board.
- 8 Press the plastic rivet until the rivet snaps into place.



Figure 136. Installing the TPM

### Next steps

- 1 Install the system board.
- 2 Follow the procedure listed in [After working inside your system](#).

### Related link

[Installing system board](#)

# Initializing TPM for BitLocker users

Initialize the TPM.

For more information, see <http://technet.microsoft.com/en-us/library/cc753140.aspx>.

The **TPM Status** changes to **Enabled, Activated**.

# Initializing the TPM 1.2 for TXT users

- 1 While booting your system, press F2 to enter System Setup.
- 2 On the **System Setup Main Menu** screen, click **System BIOS > System Security Settings**.
- 3 From the **TPM Security** option, select **On with Pre-boot Measurements**.
- 4 From the **TPM Command** option, select **Activate**.
- 5 Save the settings.
- 6 Restart your system.
- 7 Enter **System Setup** again.
- 8 On the **System Setup Main Menu** screen, click **System BIOS > System Security Settings**.
- 9 From the **Intel TXT** option, select **On**.

# Initializing the TPM 2.0 for TXT users

- 1 While booting your system, press F2 to enter System Setup.
- 2 On the **System Setup Main Menu** screen, click **System BIOS > System Security Settings**.
- 3 From the **TPM Security** option, select **On**.
- 4 Save the settings.
- 5 Restart your system.
- 6 Enter **System Setup** again.
- 7 On the **System Setup Main Menu** screen, click **System BIOS > System Security Settings**.
- 8 Select the **TPM Advanced Settings** option.
- 9 From the **TPM2 Algorithm Selection** option, select **SHA256**, then go back to **System Security Settings** screen.
- 10 On the **System Security Settings** screen, from the **Intel TXT** option, select **On**.
- 11 Save the settings.
- 12 Restart your system.

# Control panel

A control panel allows you to manually control the inputs to the server.

Your system supports:

- Left control panel: Left control panel contains status LEDs, system ID button, and iDRAC Quick Sync 2 (optional).
- Right control panel: Right control panel contains power button, USB 2.0 ports, VGA port, micro USB for iDRAC Direct, and status LED for iDRAC Direct.



# Removing the left control panel

## Prerequisites

- 1 Follow the safety guidelines listed in [Safety instructions](#).
- 2 Follow the procedure listed in [Before working inside your system](#).
- 3 Remove the cooling fan assembly.
- 4 Remove the air shroud.

**NOTE:** Ensure that you note the routing of the cables as you remove them from the system board. You must route the cables properly when you replace them to prevent the cables from being pinched or crimped.

## Steps

- 1 Pull the cable latch and disconnect the control panel cable from the system board connector.
- 2 Using Phillips #1 screwdriver, remove the screws to remove the cable cover, which secure the control panel and cable tube to the system.
- 3 Holding the control panel and cable tube by its sides, remove the control panel and cable tube away from the system.

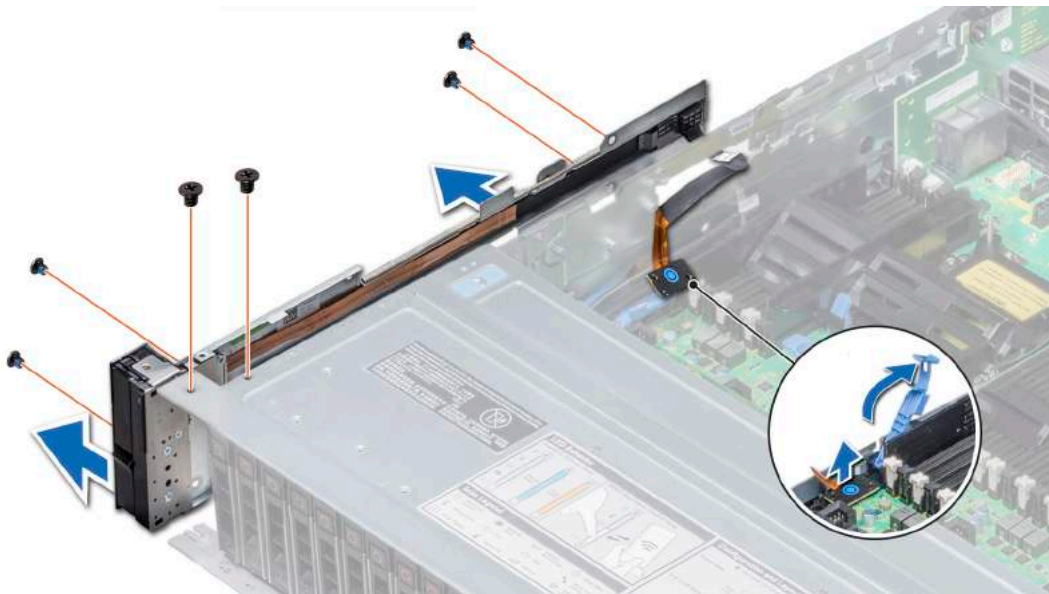

Figure 137. Removing left control panel

## Next step

Install the left control panel.

## Related link

- [Removing the cooling fan assembly](#)
- [Removing the air shroud](#)
- [Installing the left control panel](#)

# Installing the left control panel

## Prerequisite

Follow the safety guidelines listed in [Safety instructions](#).



## Steps

- 1 Route the control panel cable through the side wall of the system.
- 2 Align the control panel with the control panel slot on the system and attach the control panel to the system.
- 3 Connect the control panel cable to the system board connector and secure it using cable latch.
- 4 Using Phillips #1 screwdriver, install the screws that secure the control panel and cable tube to the system.

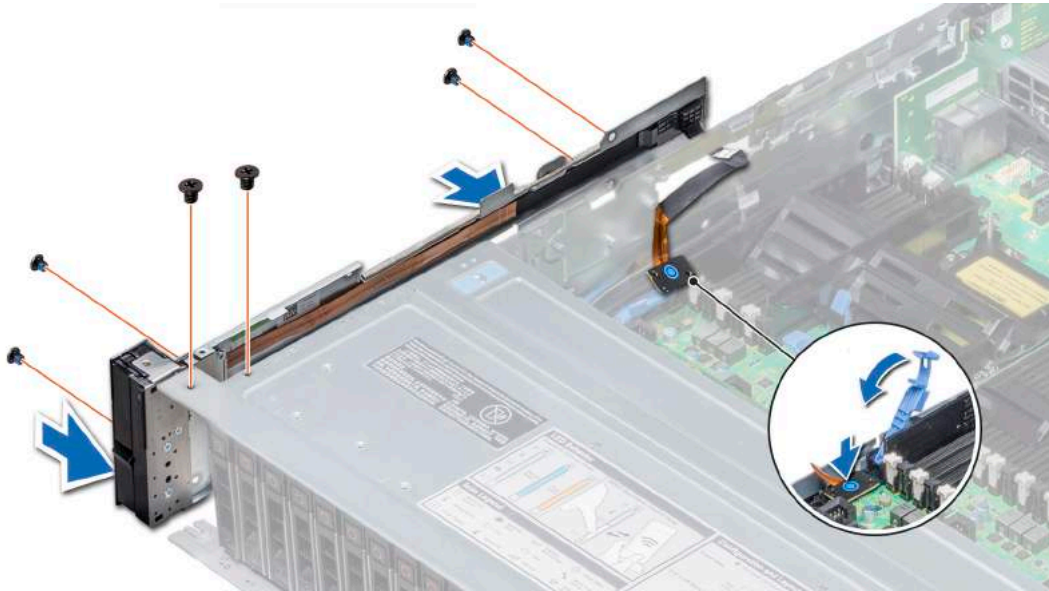

**Figure 138. Installing left control panel**

## Next steps

- 1 Install the air shroud.
- 2 Install the cooling fan assembly.
- 3 Follow the procedure listed in [After working inside your system](#).

## Related link

[Installing the air shroud](#)

[Installing the cooling fan assembly](#)

# Removing the right control panel

## Prerequisites

- 1 Follow the safety guidelines listed in [Safety instructions](#).
- 2 Follow the procedure listed in [Before working inside your system](#).

**NOTE:** Ensure that you note the routing of the cables as you remove them from the system board. You must route the cables properly when you replace them to prevent the cables from being pinched or crimped.

- 3 Remove the air shroud.
- 4 Remove the cooling fan assembly.

## Steps

- 1 Disconnect the VGA cable from the system board.
- 2 Pull the cable latch and disconnect the control panel cable from the system board connector.
- 3 Using Phillips #1 screwdriver, remove the screws that secure the control panel and cable tube to the system.

- 4 Holding the control panel and cable tube by its sides, remove the control panel and cable tube away from the system.

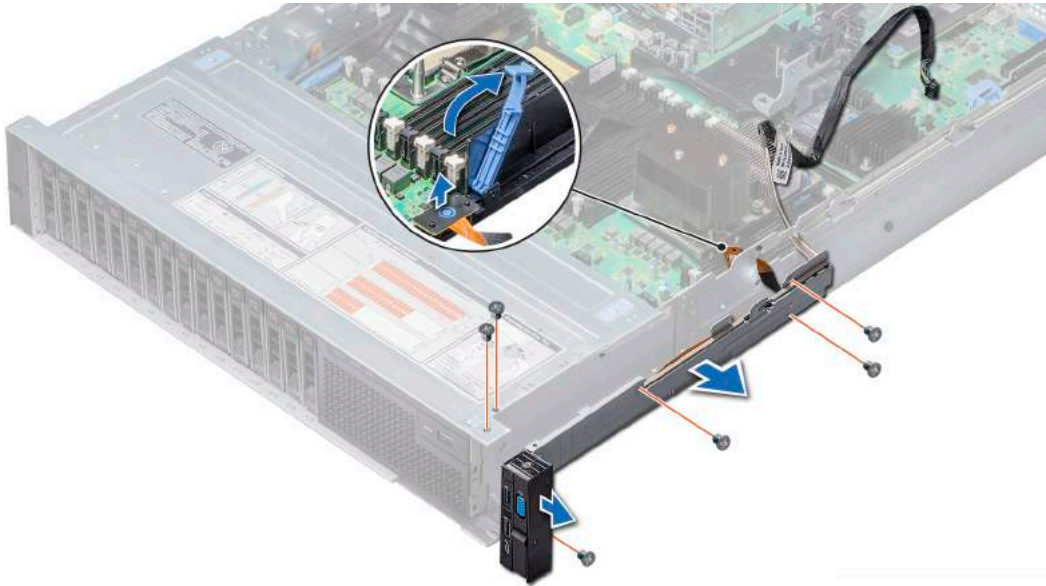

**Figure 139. Removing right control panel**

**Next step**

Install the right control panel.

**Related link**

- [Removing the air shroud](#)
- [Removing the cooling fan assembly](#)
- [Installing the right control panel](#)

## Installing the right control panel

**Prerequisite**

Follow the safety guidelines listed in [Safety instructions](#).

**Steps**

- 1 Route the control panel cable and VGA cable through the side wall of the system.
- 2 Align the control panel with the control panel slot on the system and attach the control panel to the system.
- 3 Connect the VGA cable to the system board.
- 4 Connect the control panel cable to the system board and secure it using cable latch.
- 5 Using Phillips #1 screwdriver, install the screw that secures the control panel and cable tube to the system.

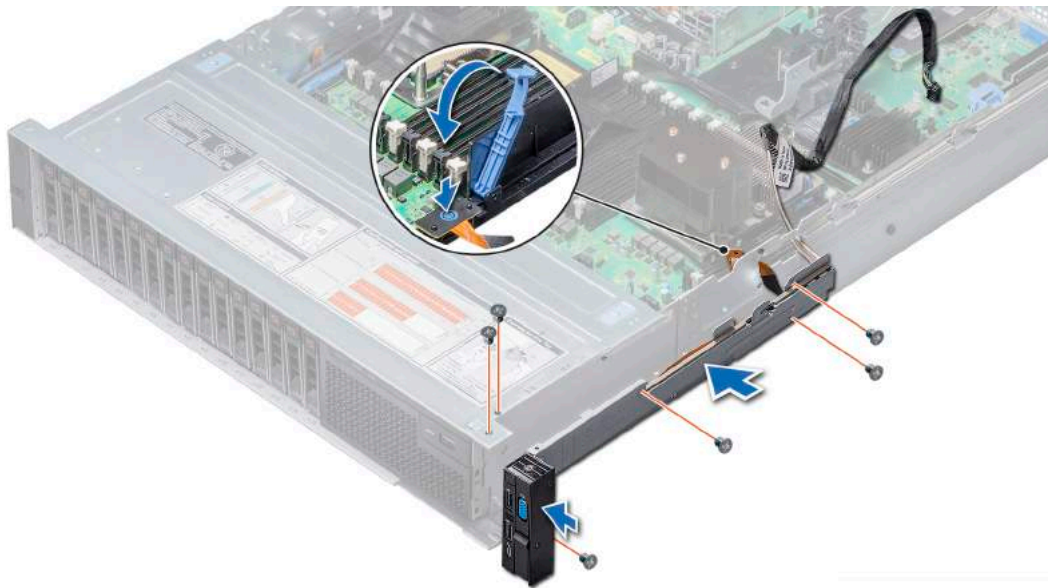

**Figure 140. Installing right control panel**

**Next steps**

- 1 Install the cooling fan assembly.
- 2 Install the air shroud.
- 3 Follow the procedure listed in [After working inside your system](#).

**Related link**

[Installing the cooling fan assembly](#)

[Installing the air shroud](#)

# Using system diagnostics

If you experience a problem with your system, run the system diagnostics before contacting Dell for technical assistance. The purpose of running system diagnostics is to test your system hardware without using additional equipment or risking data loss. If you are unable to fix the problem yourself, service and support personnel can use the diagnostics results to help you solve the problem.

## Dell Embedded System Diagnostics

① **NOTE:** The Dell Embedded System Diagnostics is also known as Enhanced Pre-boot System Assessment (ePSA) diagnostics.

The Embedded System Diagnostics provides a set of options for particular device groups or devices allowing you to:

- Run tests automatically or in an interactive mode
- Repeat tests
- Display or save test results
- Run thorough tests to introduce additional test options to provide extra information about the failed device(s)
- View status messages that inform you if tests are completed successfully
- View error messages that inform you of problems encountered during testing

## Running the Embedded System Diagnostics from Boot Manager

Run the Embedded System Diagnostics (ePSA) if your system does not boot.

- 1 When the system is booting, press F11.
- 2 Use the up arrow and down arrow keys to select **System Utilities > Launch Diagnostics**.
- 3 Alternatively, when the system is booting, press F10, select **Hardware Diagnostics > Run Hardware Diagnostics**.

The **ePSA Pre-boot System Assessment** window is displayed, listing all devices detected in the system. The diagnostics starts executing the tests on all the detected devices.

## Running the Embedded System Diagnostics from the Dell Lifecycle Controller

- 1 As the system boots, press F10.
- 2 Select **Hardware Diagnostics → Run Hardware Diagnostics**.

The **ePSA Pre-boot System Assessment** window is displayed, listing all devices detected in the system. The diagnostics starts executing the tests on all the detected devices.

## System diagnostic controls

Menu	Description
<b>Configuration</b>	Displays the configuration and status information of all detected devices.
<b>Results</b>	Displays the results of all tests that are run.
<b>System health</b>	Provides the current overview of the system performance.
<b>Event log</b>	Displays a time-stamped log of the results of all tests run on the system. This is displayed if at least one event description is recorded.

# Jumpers and connectors

This topic provides specific information about the jumpers. It also provides some basic information about jumpers and switches and describes the connectors on the various boards in the system. Jumpers on the system board help to disable the system and setup passwords. You must know the connectors on the system board to install components and cables correctly.

## Topics:

- [System board jumpers and connectors](#)
- [System board jumper settings](#)
- [Disabling forgotten password](#)

# System board jumpers and connectors

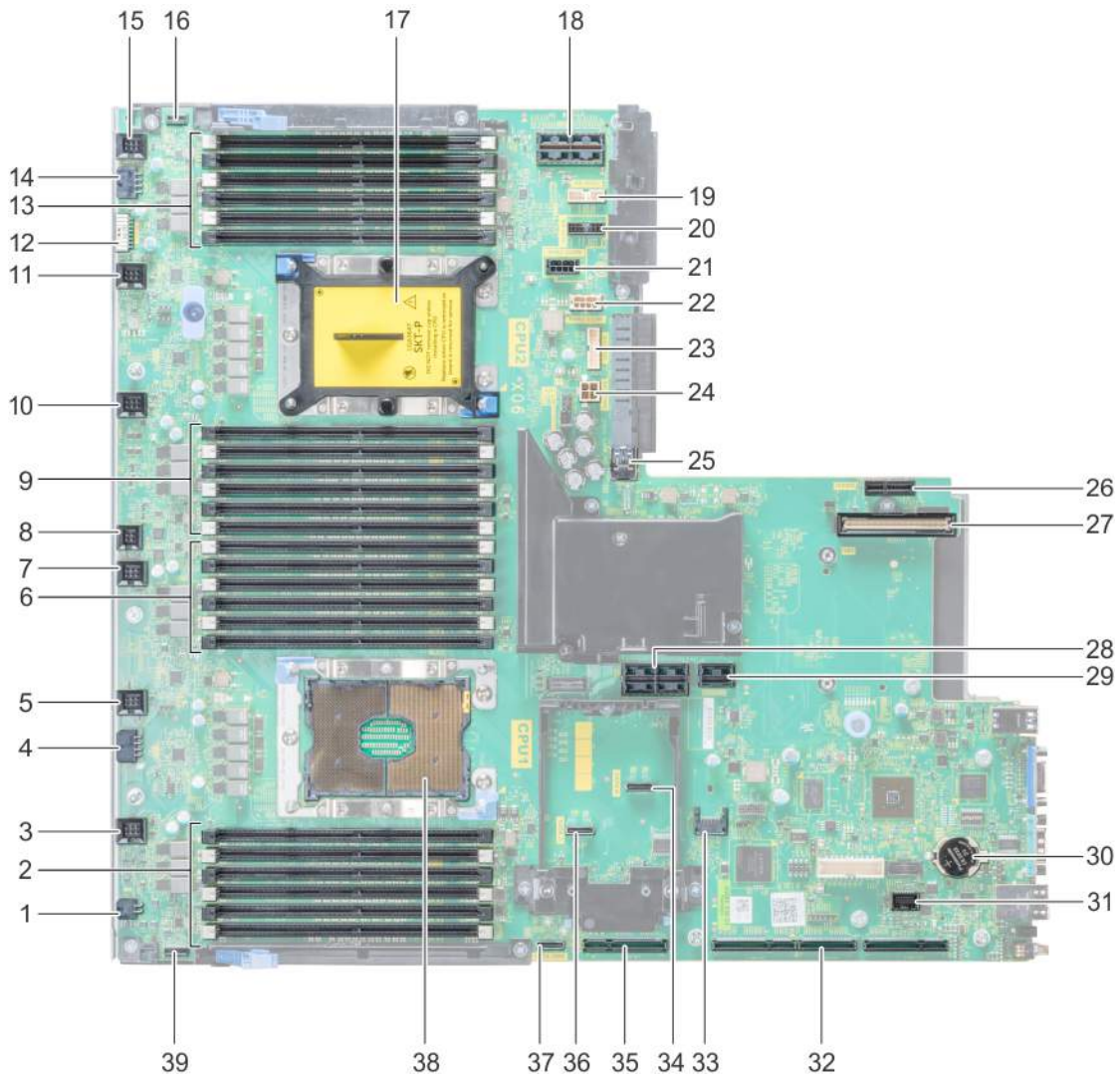

Figure 141. System board jumpers and connectors

Table 45. System board jumpers and connectors

Item	Connector	Description
1	J_ODD	Optical drive power connector
2	A7, A1, A8, A2, A9, A3	Memory module sockets
3	J_FAN2U_6	Cooling fan 6 connector
4	J_BP3	Backplane 3 power connector
5	J_FAN2U_5	Cooling fan 5 connector
6	A6, A12, A5, A11, A4, A10	Memory module sockets
7	J_FAN2U_4	Cooling fan 4 connector







Item	Connector	Description
8	INTRUSION_DET	Intrusion switch connector
9	B7, B1, B8, B2, B9, B3	Memory module sockets
10	J_FAN2U_3	Cooling fan 3 connector
11	J_FAN2U_2	Cooling fan 2 connector
12	J_BP_SIG1	Backplane 1 signal connector
13	B6, B12, B5, B11, B4, B10	Memory module sockets
14	J_BP1	Backplane 1 power connector
15	J_FAN2U_1	Cooling fan 1 connector
16	P_LFT_CP	Left control panel connector
17	CPU2	CPU2 processor and heat sink module socket (with dust cover)
18	J_R3_X24	Riser 3 connector
19	J_BP_SIG2	Backplane 2 signal connector
20	J_BP_SIG0	Backplane 0 signal connector
21	J_BP0 (RSR3_225W)	Backplane 0 power connector (Riser 3 PCIe 225 W power)
22	J_BP2 (RSR2_225W)	Backplane 2 power connector (Riser 2 PCIe 225 W power)
23	J_BATT_SIG	NVDIMM-N battery signal connector
24	J_BATT_PWR	NVDIMM-N battery power connector
25	J_USB_INT	Internal USB connector
26	J_IDSDM	IDS DM/vFlash connector
27	J_NDC	NDC connector
28	J_R2_X24_IT9	Riser 2 connector
29	J_R2_3R_X8_IT9	Riser 2 connector
30	BATTERY	Battery connector
31	J_FRONT_VIDEO	Video connector
32	J_R1_SS82_3 and J_R1_SS60_1	Riser 1 connector
33	J_TPM_MODULE	TPM connector
34	J_SATA_B	SATA B connector
35	J_R1_SS82_1	Riser 1 connector (Mini PERC option)
36	J_SATA_A	SATA A connector
37	J_SATA_C	SATA C connector (Optical drive SATA connector)
38	CPU1	CPU1 processor and heat sink module
39	P_RGT_CP	Right control panel connector

# System board jumper settings

For information on resetting the password jumper to disable a password, see the Disabling a forgotten password section.

**Table 46. System board jumper settings**

Jumper	Setting	Description
PWRD_EN	 2 4 6 (default)	The BIOS password feature is enabled.
	 2 4 6	The BIOS password feature is disabled. iDRAC local access is unlocked at next AC power cycle. iDRAC password reset is enabled in F2 iDRAC settings menu.
NVRAM_CLR	 1 3 5 (default)	The BIOS configuration settings are retained at system boot.
	 1 3 5	The BIOS configuration settings are cleared at system boot.

## Related link

[Disabling forgotten password](#)

# Disabling forgotten password

The software security features of the system include a system password and a setup password. The password jumper enables or disables password features and clears any password(s) currently in use.

## Prerequisite

**⚠ CAUTION:** Many repairs may only be done by a certified service technician. You should only perform troubleshooting and simple repairs as authorized in your product documentation, or as directed by the online or telephone service and support team. Damage due to servicing that is not authorized by Dell is not covered by your warranty. Read and follow the safety instructions that are shipped with your product.

## Steps

- 1 Turn off the system, including any attached peripherals, and disconnect the system from the electrical outlet.
- 2 Remove the system cover.
- 3 Move the jumper on the system board jumper from pins 2 and 4 to pins 4 and 6.
- 4 Install the system cover.

The existing passwords are not disabled (erased) until the system boots with the jumper on pins 4 and 6. However, before you assign a new system and/or setup password, you must move the jumper back to pins 2 and 4.

**ⓘ NOTE:** If you assign a new system and/or setup password with the jumper on pins 4 and 6, the system disables the new password(s) the next time it boots.

- 5 Reconnect the system to its electrical outlet and turn on the system, including any attached peripherals.
- 6 Turn off the system, including any attached peripherals, and disconnect the system from the electrical outlet.
- 7 Remove the system cover.
- 8 Move the jumper on the system board jumper from pins 4 and 6 to pins 2 and 4.
- 9 Install the system cover.
- 10 Reconnect the system to its electrical outlet and turn on the system, including any attached peripherals.
- 11 Assign a new system and/or setup password.

**Related link**

[Removing the system cover](#)

[Installing the system cover](#)

# Getting help

Topics:

- [Contacting Dell](#)
- [Documentation feedback](#)
- [Accessing system information by using QRL](#)
- [Receiving automated support with SupportAssist](#)

## Contacting Dell

Dell provides several online and telephone based support and service options. If you do not have an active internet connection, you can find contact information about your purchase invoice, packing slip, bill, or Dell product catalog. Availability varies by country and product, and some services may not be available in your area. To contact Dell for sales, technical assistance, or customer service issues:

- 1 Go to [Dell.com/support](https://Dell.com/support).
- 2 Select your country from the drop-down menu on the lower right corner of the page.
- 3 For customized support:
  - a Enter your system Service Tag in the **Enter your Service Tag** field.
  - b Click **Submit**.The support page that lists the various support categories is displayed.
- 4 For general support:
  - a Select your product category.
  - b Select your product segment.
  - c Select your product.The support page that lists the various support categories is displayed.
- 5 For contact details of Dell Global Technical Support:
  - a Click [Global Technical Support](#).
  - b The **Contact Technical Support** page is displayed with details to call, chat, or e-mail the Dell Global Technical Support team.

## Documentation feedback

You can rate the documentation or write your feedback on any of our Dell documentation pages and click **Send Feedback** to send your feedback.

## Accessing system information by using QRL

You can use the Quick Resource Locator (QRL) to get immediate access to the information about your system. The QRL is located on the top of the system cover and provides access to generic information about your system. If you want to access information specific to the system service tag, such as configuration and warranty, you can access QR code located on the system Information tag.

### Prerequisites

Ensure that your smart phone or tablet has the QR code scanner installed.

The QRL includes the following information about your system:

- How-to videos

- Reference materials, including the Owner’s Manual, LCD diagnostics, and mechanical overview
- A direct link to Dell to contact technical assistance and sales teams

### Steps

- 1 Go to **Dell.com/QRL** and navigate to your specific product or
- 2 Use your smart phone or tablet to scan the model-specific Quick Resource (QR) code on your PowerEdge system or in the Quick Resource Locator section.

## Quick Resource Locator for PowerEdge R740 and R740xd systems



Figure 142. Quick Resource Locator for PowerEdge R740 and R740xd systems

## Receiving automated support with SupportAssist

Dell SupportAssist is an optional Dell Services offering that automates technical support for your Dell server, storage, and networking devices. By installing and setting up a SupportAssist application in your IT environment, you can receive the following benefits:

- **Automated issue detection** — SupportAssist monitors your Dell devices and automatically detects hardware issues, both proactively and predictively.
- **Automated case creation** — When an issue is detected, SupportAssist automatically opens a support case with Dell Technical Support.
- **Automated diagnostic collection** — SupportAssist automatically collects system state information from your devices and uploads it securely to Dell. This information is used by Dell Technical Support to troubleshoot the issue.
- **Proactive contact** — A Dell Technical Support agent contacts you about the support case and helps you resolve the issue.

The available benefits vary depending on the Dell Service entitlement purchased for your device. For more information about SupportAssist, go to [Dell.com/SupportAssist](http://Dell.com/SupportAssist).